

**OFF-
ROAD
LIVIN'**



Can-Am®

MAVERICK X3

PRODUCT SPEC BOOK
VEHICLE SPECIFICATIONS • ACCESSORIES

2022

2022 MAVERICK X3

VEHICLE SPECIFICATIONS

FEATURED PACKAGES FOR MAVERICK X3

Maverick X3 DS Turbo	6
Maverick X3 X rs Turbo RR with Smart-Shox	8

COMPARATIVE CHART

Maverick X3 Lineup	10
--------------------	----

ACCESSORIES

Roofs	18
Soft Cab Enclosure	19
Windshields & Mirrors	19
Doors	21
Skid Plates	23
Bumpers & Guards	24
Seat Accessories	28
LinQ®: Easy On, Easy Off Cargo	29
Racks & Storage	34
Lights	35
Audio & Communication Systems	39
Electrical & Electronic Accessories	40
Winches & Hitches	42
Performance	44
Trailer	48
Apache Track Systems	48
ProMount Plows	50
Tyres & Rims	52

can-am
MAVERICK X3



VEHICLE SPECIFICATIONS



VEHICLE SPECIFICATIONS

FEATURED PACKAGES FOR MAVERICK X3

Maverick X3 DS Turbo	6
Maverick X3 X rs Turbo RR with Smart-Shox	8

COMPARATIVE CHART

Maverick X3 Lineup	10
--------------------	-----------

**OFF-
ROAD
LIVIN'**



MAVERICK X3 DS TURBO

HIGHLIGHTS

DEFIANT	<ul style="list-style-type: none"> • Trademark Can-Am DNA with next generation design • Low seating position • Ergo-Lok cockpit with four-way adjustable seats
POWERFUL	<ul style="list-style-type: none"> • 120 hp turbocharged Rotax® ACE engine • Advanced airflow dynamics • QRS-X transmission
PRECISE	<ul style="list-style-type: none"> • TTX suspension with industry-leading travel • Ultra efficient and lightweight chassis • Sharpest handling features
PLATFORM FEATURES	<ul style="list-style-type: none"> • 64 in. wide • 102 in. wheelbase • 14 in. of ground clearance • High-torque Dynamic Power Steering (DPS™) • 20 in. suspension travel • FOX 2.5 PODIUM QS3 piggyback shocks • 14 in. aluminum wheels • 30 in. Maxxis Carnivore tires • 4.5 in. digital display with keypad • Rear tow hook

ENGINE	TURBO
Type	120 hp, Rotax ACE (Advanced Combustion Efficiency) 900 cc turbocharged triple-cylinder engine, liquid-cooled and high-performance air filter
Fuel Delivery System	Intelligent Throttle Control (iTC™) with Electronic Fuel Injection (EFI)
Transmission	Quick Response System X (QRS-X) CVT with high airflow, L/H/N/R/P
Drive Train	Lockable front differential with exclusive Smart-Lok* technology. True 4-mode traction system: 2WD/4WD with front diff. lock/4WD TRAIL ACTIV/4WD TRAIL
Power Steering	High-torque Tri-Mode Dynamic Power Steering (DPS)
SUSPENSIONS	
Front Suspension	Double A-arm with sway bar/20 in. (50.8 cm) travel
Front Shocks	FOX 2.5 PODIUM piggyback with QS3 compression adjustment
Rear Suspension	4-link Torsional Trailing-arm X (TTX) with sway bar/20 in. (50.8 cm) travel
Rear Shocks	FOX 2.5 PODIUM piggyback with QS3 compression adjustment and bottom-out control
TIRES & WHEELS	
Front Tires	Maxxis Carnivore 30 x 10 x 14 in.
Rear Tires	Maxxis Carnivore 30 x 10 x 14 in.
Wheels	14 in. cast-aluminum
BRAKES	
Front	Dual 262 mm ventilated disc brakes with hydraulic twin-piston calipers
Rear	Dual 248 mm ventilated disc brakes with hydraulic twin-piston calipers

DIMENSIONS & CAPACITIES

Estimated Dry Weight	1,546 lb (701.3 kg)
Chassis/Cage	Dual-phase 980 steel
L x W x H	132 x 64 x 65.4 in. (335.3 x 162.5 x 166.1 cm)
Wheelbase	102 in. (259.1 cm)
Ground Clearance	14 in. (35.6 cm)
Rack Capacity	200 lb (91 kg) with LinQ™ quick-attach
Storage Capacity	Total: 2.5 gal (9.4 L) Glove box: 1.6 gal (6.2 L) Central console: 0.8 gal (2.8 L) Cup holders: 0.1 gal (0.4 L)
Fuel Capacity	10.5 gal (40 L)

FEATURES

Gauge	4.5 in. wide digital display with keypad: speedometer, tachometer, odometer, trips and hour meters, fuel, gear position, SPORT/ECO™ mode, seat belt and 4 x 4 indicator, front and rear diff. lock indicators, diagnostics, clock, battery voltage, engine temperature, DPS mode
Instrumentation	Lighter-type DC outlet in central console
Anti-theft System	RF Digitally Encoded Security System (D.E.S.S.™) with Start/Stop button
Lighting	LED headlights and tail lights
Winch	N/A
Magneto	650 W
Protection	Integrated front bumper Quarter doors HMWPE full skid plate Rear tow hook

WARRANTY

Factory Warranty	2 years/15,000 km warranty, whichever comes first
------------------	---



 Octane Blue

FEATURE HIGHLIGHTS



Grip It and Rip It

Now standard: Smart-Lok is the most advanced off-road front differential, period. It's fully lockable on-the-fly, and its four automatic modes return maximum traction in every condition.



Shocking Versatility

The Can-Am Maverick X3 is tuned to win, leading its class thanks to features like bottom-out control with dual speed compression. Its adjustable FOX Racing† piggyback shocks can hit off-road terrain at heart-pounding speeds—and come out on top.



High-Performance Wheels and Tyres

The Can-Am Maverick X3 gets its imposing look in part from 30 inch Maxxis Carnivore† tyres with 14 inch cast-aluminum wheels. It's a beastly tyre setup that's ready to roam far and wide right out of the showroom.



Stands Out & Stands Tall

Who says size doesn't matter? At 14 inches high, the Can-Am Maverick X3 looks down on anything in its way. That amount of ground clearance means it can easily absorb shocks and avoid damage to the chassis and underbody from scraping.



Trip Info at Your Fingertips

For riders, everything worth paying attention to is on the Can-Am Maverick X3's 4.5 inch digital display. At that size, it's readable in all conditions and puts all the vehicle's information and controls at the tip of the driver's gloves.

MAVERICK X3 X rs TURBO RR WITH SMART-SHOX

HIGHLIGHTS

DEFIANT	<ul style="list-style-type: none"> • Trademark Can-Am DNA with next-generation design • Low seating position • Ergo-Lok cockpit with four-way adjustable seats
POWERFUL	<ul style="list-style-type: none"> • Industry-leading 200 hp turbocharged and intercooled Rotax® ACE engine • Advanced airflow dynamics • QRS-X transmission
PRECISE	<ul style="list-style-type: none"> • TTX suspension with industry-leading travel • Ultra efficient and lightweight chassis • Sharpest handling features
PLATFORM FEATURES	<ul style="list-style-type: none"> • 72 in. wide • 102 in. wheelbase • 16 in. of ground clearance • High-torque Dynamic Power Steering (DPS™) • Up to 24 in. of suspension travel • Rear tow hook

SPECIFIC TO X rs TURBO RR PACKAGE with Smart-Shox	<ul style="list-style-type: none"> • Belt-monitoring system • 200 hp Turbo RR engine • Smart-Lok™** front differential • Smart-Shox** Technology featuring DDA Valve • FOX 3.0 PODIUM shocks with bypass • 14 in. aluminum beadlock wheels • 32 in. Maxxis Carnivore tires • 4-point harness with shoulder pads • HMWPE full skid plate • Full roof • X-package graphics/seats • 7.6 in. digital display with keypad • Can-Am LED signature • 850 W magneto • Painted color options
--	--

ENGINE	TURBO RR
Type	200 hp, Rotax ACE (Advanced Combustion Efficiency) 900 cc turbocharged triple-cylinder engine, liquid-cooled with integrated intercooler and high-performance air filter
Fuel Delivery System	Intelligent Throttle Control (iTC™) with Electronic Fuel Injection (EFI)
Transmission	PDrive primary and Quick Response System X (QRS-X) CVT with high airflow, L/H/N/R/P
Drive Train	Lockable front differential with exclusive Smart-Lok technology. True 4-mode traction system: 2WD/4WD with front diff. lock/4WD TRAIL ACTIV/4WD TRAIL
Power Steering	High-torque Tri-Mode Dynamic Power Steering (DPS)
SUSPENSIONS	
Front Suspension	Double A-arm with sway bar/22 in. (55.9 cm) travel/ Trophy truck-inspired arms
Front Shocks	FOX 2.5 PODIUM piggyback with bypass and Smart-Shox Technology featuring DDA valve (Dynamic Damping Adjustment)
Rear Suspension	4-link Torsional Trailing-arm X (TTX) with sway bar/24 in. (61 cm) travel
Rear Shocks	FOX 3.0 PODIUM remote reservoir with bypass and Smart-Shox Technology featuring DDA valve (Dynamic Damping Adjustment)
TIRES & WHEELS	
Front Tires	Maxxis Carnivore 32 x 10 x 14 in.
Rear Tires	Maxxis Carnivore 32 x 10 x 14 in.
Wheels	14 in. cast-aluminum beadlock
BRAKES	
Front	Dual 262 mm ventilated disc brakes with hydraulic twin-piston calipers
Rear	Dual 248 mm ventilated disc brakes with hydraulic twin-piston calipers

DIMENSIONS & CAPACITIES

Estimated Dry Weight	1,699 lb (770.7 kg)
Chassis/Cage	Dual-phase 980 steel
L x W x H	132 x 72.7 x 68.5 in. (335.3 x 184.7 x 174 cm)
Wheelbase	102 in. (259.1 cm)
Ground Clearance	16 in. (40.6 cm)
Rack Capacity	200 lb (91 kg) with LinQ™ quick-attach
Storage Capacity	Total: 2.5 gal (9.4 L) Glove box: 1.6 gal (6.2 L) Central console: 0.8 gal (2.8 L) Cup holders: 0.1 gal (0.4 L)
Fuel Capacity	10.5 gal (40 L)

FEATURES

Gauge	7.6 in. wide digital display with keypad: speedometer, tachometer, odometer, trips and hour meters, fuel, gear position, SPORT/ECO™ mode, seat belt and 4 x 4 indicator, front and rear diff. lock indicators, diagnostics, clock, battery voltage, engine temperature, DPS mode, Smart-Shox Suspension Mode
Instrumentation	Lighter-type DC outlet in central console
Anti-theft System	RF Digitally Encoded Security System (D.E.S.S.™) with Start/Stop button
Lighting	LED headlights and tail lights with unique Can-Am LED signature
Winch	N/A
Magneto	850 W
Protection	Integrated front bumper Quarter doors Full roof 4-point harness with shoulder pads HMWPE full skid plate Rear tow hook

WARRANTY

Factory Warranty	2 years/15,000 km warranty, whichever comes first
------------------	---



■ Intense Blue, Carbon Black & Chalk Gray

FEATURE HIGHLIGHTS



Leading the Charge

One word to describe the 200 horsepower Rotax Turbo RR engine: relentless. How much horsepower should the world's leading sport side-by-side have? We say more. The newly-boosted output delivers faster acceleration and more get-up-and-go in every driving situation.



Grip It and Rip It

Smart-Lok is the most advanced off-road front differential, period. It's fully lockable on-the-fly, and its four automatic modes return maximum traction in every condition.



Lightning Fast Suspension Response

Before Smart-Shox, customers had to choose between race-winning handling and a comfortable, all-day ride. Not anymore. Smart-Shox self-adjusts up to 200 times per second, boasting near-instantaneous response to rider inputs and terrain. It's the industry's fastest suspension response. Period.



Shocking Versatility

The Can-Am Maverick X3 X rs is tuned to win. Equipped with Smart-Shox and trophy truck-inspired arm suspension, this ride can hit any terrain at top speeds—and come out on top.



High-Performance Wheels and Tyres

The Can-Am Maverick X3 X rs gets its imposing look in part from 32 inch Maxxis Carnivore tyres with 14 inch cast-aluminum beadlock wheels. It's a beastly tyre setup that's ready to roam far and wide right out of the showroom.



Harness Every Adventure

With 4-point harnesses awaiting every passenger, a fun and safe ride is only a few clicks away. Standard shoulder pads and Ergo-Lok seats add to rider comfort and safety.





Trip Info at Your Fingertips

Everything needed to control the perfect ride is on the Can-Am Maverick X3 X rs's 7.6 inch dash-mounted digital display with keypad. At that size, it's readable in all conditions and puts all the vehicle's information and controls at the ready.



Riding After Dark

Safe riding at night is here. Can-Am LED headlights and tail lights with high and low beams shine brighter, consume less power, and last longer than standard halogen bulbs. Plus, the rig looks plain cool with its headlights lighting up the night.

MAVERICK X3		DS TURBO	X rc TURBO RR 72
			
COLOR OPTIONS		Octane Blue	Chalk Gray & Magma Red
ENGINES	Type	120 hp, Rotax® ACE (Advanced Combustion Efficiency) 900 cc Turbocharged Triple-cylinder engine, liquid cooled and high-performance air filter	200 hp, Rotax ACE (Advanced Combustion Efficiency) 900 cc Turbocharged Triple-cylinder engine, liquid cooled with integrated intercooler and high-performance air filter
	Fuel Delivery System	Intelligent Throttle Control (ITC) with Electronic Fuel Injection (EFI)	
	Transmission	Quick Response System X (QRS-X) CVT with high airflow, L/H/N/R/P	PDrive primary and Quick Response System X (QRS-X) CVT with high airflow, L/H/N/R/P
	Drive Train	Lockable front differential with exclusive Smart-Lok* technology. True 4 modes traction system: 2WD/4WD with front diff. lock/4WD TRAIL ACTIV/4WD TRAIL	Lockable front differential with exclusive Smart-Lok* technology. True 4 modes traction system: 2WD/4WD with front diff. lock/4WD ROCK/4WD TRAIL
	Driving Assistance	High torque Tri-Mode Dynamic Power Steering (DPS)	
SUSPENSIONS	Front Suspension	Double A-arm with sway bar/ 20 in. (50.8 cm) travel	Trophy truck inspired double arched A-arm with sway bar/22 in. (55.9 cm) travel
	Front Shocks	FOX 2.5 PODIUM Piggyback with QS3 ¹ compression adjustment	FOX 2.5 PODIUM RC2 Piggyback with bypass, dual speed compression and rebound adjustments
	Rear Suspension	4-link Torsional Trailing-arm X (TTX) with sway bar/20 in. (50.8 cm) travel	4-link Torsional Trailing-arm X (TTX) with sway bar and arched lower links/24 in. (61 cm) travel
	Rear Shocks	FOX 2.5 PODIUM Piggyback with QS3 compression adjustment and bottom-out control	FOX 3.0 PODIUM RC2 remote reservoir with bypass, dual speed compression and rebound adjustment
TYRES/ WHEELS	Front Tyres	Maxxis Carnivore 30 x 10 x 14 in.	Maxxis Liberty 32 x 10 x 15 in.
	Rear Tyres	Maxxis Carnivore 30 x 10 x 14 in.	Maxxis Liberty 32 x 10 x 15 in.
	Wheels	14 in. cast-aluminum	15 in. cast-aluminum beadlock
BRAKES	Front	Dual 262 mm disc brakes with hydraulic twin-piston calipers	
	Rear	Dual 248 mm disc brakes with hydraulic twin-piston calipers	
DIMENSIONS/CAPACITIES	Estimated Dry Weight	1,546 lb (701.3 kg)	1,843 lb (836 kg)
	Chassis/Cage	Dual-phase 980 steel	
	L x W x H	132 x 64 x 65.4 in. (335.3 x 162.5 x 166.1 cm)	134.5 x 72.8 x 68.5 in. (341.6 x 184.9 x 174 cm)
	Wheelbase	102 in. (259.1 cm)	
	Ground Clearance	14 in. (35.6 cm)	16 in. (40.6 cm)
	Rack Capacity	200 lb (91 kg) with LinQ quick-attach	
	Storage Capacity	Total: 2.5 gal (9.4 L) Glove box: 1.6 gal (6.2 L) Central console: 0.8 gal (2.8 L) Cup holders: 0.1 gal (0.4 L)	
	Fuel Capacity	10.5 gal (40 L)	
FEATURES	Gauge	4.5 in. wide digital display with keypad: Speedometer, tachometer, odometer, trips and hour meters, fuel, gear position, SPORT/ECO mode, seat belt and 4 x 4 indicator, front and rear diff lock indicators, diagnostics, clock, battery voltage, engine temperature, DPS mode	7.6 in. wide digital display with keypad: Speedometer, tachometer, odometer, trips and hour meters, fuel, gear position, SPORT/ECO modes, seat belt and 4 x 4 indicator, front and rear diff lock indicators, diagnostics, clock, battery voltage, engine temperature, DPS mode
	Instrumentation	Lighter type DC Outlet in central console	
	Anti-theft System	RF Digitally Encoded Security System (D.E.S.S.) with Start/Stop button	
	Lighting	LED headlights and tail lights	LED headlights and tail lights with unique Can-Am LED signature
	Winch	N/A	4,500-lb (2,041 kg) winch with synthetic rope
	Magneto	650 W	850 W
	Protection	Integrated front bumper Quarter-doors HMWPE full skid plate Rear tow hook	Front bumper Half-doors Aluminum roof Intrusion bar 4-point harness with shoulder pads UHMWPE rock sliders HMWPE skidplates: Full heavy duty with differential/Under bumper/ Front and rear suspension arm Rear tow hook

*Smart-Lok was developed in conjunction with TEAM Industries, a market leader in the drive train industry.
 **Smart-Shox was developed in conjunction with Tractive Industries, a market leader in the suspension industry.

X rs TURBO RR with Smart-Shox**		MAX X rs TURBO RR Smart-Shox**
Intense Blue, Carbon Black & Chalk Gray		
200 hp, Rotax ACE (Advanced Combustion Efficiency) 900 cc Turbocharged Triple-cylinder engine, liquid cooled with integrated intercooler and high-performance air filter		
Intelligent Throttle Control (ITC) with Electronic Fuel Injection (EFI)		
PDrive primary and Quick Response System X (QRS-X) CVT with high airflow, L/H/N/R/P		
Lockable front differential with exclusive Smart-Lok* technology. True 4 modes traction system: 2WD/4WD with front diff. lock/4WD TRAIL ACTIV/4WD TRAIL		
High torque Tri-Mode Dynamic Power Steering (DPS)		
Double A-arm with sway bar/22 in. (55.9 cm) travel/Trophy truck inspired arms		
FOX 2.5 PODIUM ¹ Piggyback with bypass and Smart-Shox** Technology featuring DDA Valve (Dynamic Damping Adjustment)		
4-link Torsional Trailing-arm X (TTX) with sway bar/24 in. (61 cm) travel	4-link Torsional Trailing-arm X (TTX) with sway bar/22 in. (55.9 cm) travel	
FOX 3.0 PODIUM ¹ remote reservoir with bypass and Smart-Shox** Technology featuring DDA Valve (Dynamic Damping Adjustment)		
Maxxis Carnivore 32 x 10 x 14 in. Maxxis Carnivore 32 x 10 x 14 in. 14 in. cast-aluminum beadlock		
Dual 262 mm disc brakes with hydraulic twin-piston calipers		
Dual 248 mm disc brakes with hydraulic twin-piston calipers		
1,699 lb (770.7 kg)	1,942 lb (880.9 kg)	
Dual-phase 980 steel		
132 x 72.7 x 68.5 in. (335.3 x 184.7 x 174 cm)	165 x 72.7 x 68.5 in. (419.1 x 184.7 x 174 cm)	
102 in. (259.1 cm)	135 in. (342.9 cm)	
16 in. (40.6 cm)		
200 lb (91 kg) with LinQ quick-attach	150 lb (68 kg) with LinQ quick-attach	
Total: 2.5 gal (9.4 L) Glove box: 1.6 gal (6.2 L) Central console: 0.8 gal (2.8 L) Cup holders: 0.1 gal (0.4 L)	Total: 3 gal (11.4 L) Glove box: 1.6 gal (6.2 L) Central console: 1.1 gal (4.1 L) Cup holders: 0.3 gal (1.1 L)	
10.5 gal (40 L)		
7.6 in. wide digital display with keypad: Speedometer, tachometer, odometer, trips and hour meters, fuel, gear position, SPORT/ECO modes, seat belt and 4 x 4 indicator, front and rear diff lock indicators, diagnostics, clock, battery voltage, engine temperature, DPS mode, Smart-Shox** Suspension Mode		
Lighter type DC Outlet in central console		
RF Digitally Encoded Security System (D.E.S.S.) with Start/Stop button		
LED headlights and tail lights with unique Can-Am LED signature		
N/A		
850 W		
Integrated front bumper Quarter-doors Full roof 4-point harness with shoulder pads HMWPE full skid plate Rear tow hook		

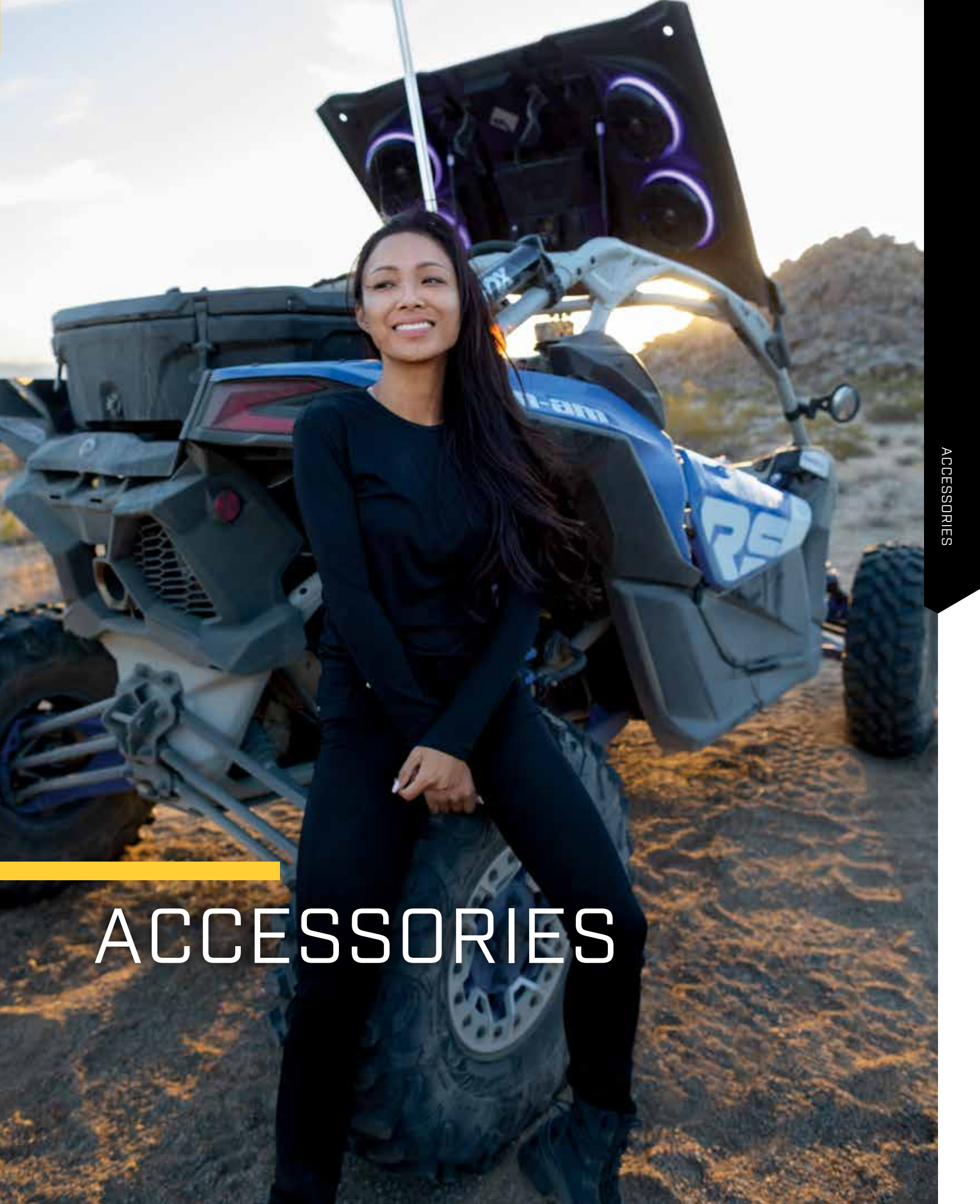

ACCESSORIES



ACCESSORIES

Roofs	18	Lights	35
Soft Cab Enclosure	19	Audio & Communication Systems	39
Windshields & Mirrors	19	Electrical & Electronic Accessories	40
Doors	21	Winches & Hitches	42
Skid Plates	23	Performance	44
Bumpers & Guards	24	Trailerling	48
Seat Accessories	28	Apache Track Systems	48
LinQ: Easy On, Easy Off Cargo	29	ProMount Plows	50
Racks & Storage	34	Tyres & Rims	52

LOAD UP AND DON'T LOOK BACK.



FIT AND COMPATIBILITY

For us, innovation is a no-brainer. All our accessories work together, right out of the box. So take your pick. Then pick some more.



STYLE AND VISION

We've upped the ante when it comes to accessories. Not just designed to look good, but perform right for real riders. All killer, no filler.



QUALITY AND RELIABILITY

Our Can-Am accessories are made right the first time. And to top it off we threw in a 1-year warranty. You're welcome. Install them yourself or at an authorized dealer.

can-am

BRP 1-YEAR LIMITED WARRANTY*

For new Can-Am accessories, genuine parts, and co-branded products sold through BRP. Includes items installed by you or an authorized BRP dealer.

*Use other than which the product is designed for will void the product limited warranty. Other exclusions may apply, the warranty is subject to the exclusions, limitations of liabilities and all other terms and conditions of BRP's standard limited warranty. See complete limited warranty or contact your Can-Am Off-Road authorized dealer. Applies only to BRP-made products or co-branded products made by currently accredited BRP partners. Purchased at an authorized BRP dealership/distributor or from a BRP-authorized online store. Unless otherwise stipulated or required by law. This limited warranty does not apply to factory installed accessories. This limited warranty does not apply on Evinrude parts and accessories. This limited warranty is effective as of March 1, 2016.

ROOFS

Sport Roof	Maverick X3	715002902
	Maverick X3 MAX	715003750



- Impact-resistant injected polypropylene.
- Excellent protection from the elements.
- Provides excellent downhill visibility.
- Windshield compatible.
- Standard on X3s model.
- Easy, tool-less installation and removal with quick-release/turn fasteners and Velcro straps.
- Easy installation.

ProVent Roof Module Kit	Maverick X3, Maverick X3 MAX	715005279
--------------------------------	------------------------------	------------------



- Provides fresh air in the cab area.
- Optimal performance with full cab enclosure.
- 4 vents provide infinite adjustment of air flow for driver and passenger.
- Filter and pre-filter to limit dust intrusion.
- Easy cleaning of filter and pre-filter.
- Patent pending water management system to keep water out of cabin while maintaining air flow.
- Outer plug closes air intake completely for winter or heavy weather.
- Sport Roof requires ProVent Module Adapter Kit.
- Not compatible with roof mounted LED bars, roof racks or roof liners, Lonestar Roof, and Bimini tops.

ProVent Roof Module Adapter Kit for Sport Roof <i>(Not illustrated)</i>	Maverick X3 Maverick X3 MAX	715006199 715006371
---	--------------------------------	--------------------------------------

- Adapter for fitting ProVent Roof Module Kit onto Maverick X3.
- Includes roof adapter and hardware.
- Requires ProVent Roof Module Kit (715005279).

Aluminum Roof	Maverick X3	■ 715004224 • Black
		■ 715002900 • Silver



- Formed aluminum roof 0.09" (2.3 mm) thick.
- Durable and lightweight.
- Sporty look.
- Windshield compatible.
- Easy and tool-less installation.

Bimini[†] Roof with Sun Visor	Maverick X3	715002901
	Maverick X3 MAX	715003749



- Heavy-duty canvas made of UV-resistant solution-dyed polyester.
- Innovative soft top comes with a hard visor that allows for storage of rolled-up soft top.
- Easy, tool-less installation and removal with quick-release/turn fasteners and Velcro straps.

Tinted Sun Visor	Maverick X3, Maverick X3 MAX	715007098
-------------------------	------------------------------	------------------



- Tinted polycarbonate construction.
- Extra protection for driver and passenger from the sun.
- Not compatible with Aluminum Roof and Full Windshields.

Lonestar Racing⁰ Aluminum Roof	Maverick X3 produced after January 1, 2017	■ 715005508 • Hyper Silver
	Maverick X3 MAX	■ 715005507 • Black
		■ 715004436 • Can-Am Red
		■ 715005516 • Hyper Silver
		■ 715005515 • Black
		■ 715004341 • Can-Am Red



- 0.083" (2.1 mm) thick aluminum roof.
- Durable and lightweight.
- Enhances the vehicle's racing appearance thanks to an authentic sporty look combined with unique graphics.
- Offers you protection from the elements with a personalized touch.
- Lower profile than other roofs.
- Compatible with Lonestar Racing Light Bar Racks.
- Not compatible with LinQ Pivoting Rack, Light Support Bar and Full Windshields.
- "Lonestar Racing for Can-Am" branded.
- Includes middle intrusion bars for installation

SOFT CAB ENCLOSURE

NON-STOCKED ITEM, SPECIAL ORDER ONLY.

Soft Cab Enclosure	Maverick X3	715003754
	Maverick X3 MAX	715003755

	<ul style="list-style-type: none"> Protection for rider and passenger from the elements. For added cabin comfort, complete your cab enclosure with Cab Seal Kit. 	<p>Includes:</p> <ul style="list-style-type: none"> Bimini Roof with Sun Visor Full Windshield — Hardcoated Upper Soft Door Panels Front Lower Door Panels Soft Rear Window
---	--	--

Cab Seal Kit <i>(Not illustrated)</i>	Maverick X3	715004433
	Maverick X3 MAX	715004434

<ul style="list-style-type: none"> Prevents dirt, dust and wind infiltration in the cab area. Improves cabin comfort for driver and passenger. Recommended with Soft Cab Enclosures.

WINDSHIELDS & MIRRORS

WINDSHIELDS

PowerFlip Windshield	Maverick X3, Maverick X3 MAX	715007097
-----------------------------	------------------------------	------------------

	<ul style="list-style-type: none"> The PowerFlip Windshield is equipped with electric cylinders that allow the rider to adjust the windshield opening at the touch of a button. Windshield is made of hardcoated polycarbonate with a rubber seal contour and a tinted top section. Allows you to quickly adapt to changing conditions by adjusting the windshield as you go. Can be fully opened for optimal visibility and ventilation, fully closed for maximum protection from the elements, and in between, you have an infinite number of opening possibilities depending on protection, visibility and air flow preferences. Compatible with Can-Am roofs.
---	--

Windshield Wiper for PowerFlip Windshield	Maverick X3, Maverick X3 MAX	715006310
--	------------------------------	------------------

	<ul style="list-style-type: none"> An ideal way to keep your windshield clear in rain or while riding through mud and water. Wiper from the top allows windshield pivoting. Includes single-speed wiper and washer-fluid dispenser. Wiper mechanism and washer-fluid dispenser perfectly concealed within the vehicle. Must be installed with the PowerFlip Windshield (sold separately).
---	---

Glass Windshield	Maverick X3, Maverick X3 MAX	715003281
-------------------------	------------------------------	------------------

	<ul style="list-style-type: none"> Curved and laminated glass full windshield. Seals firmly against the cage and protects rider and passenger from the elements. Provides the best optical clarity and abrasion resistance. Must be used with Windshield Wiper & Washer Kit to maintain clear visibility during severe riding conditions, such as mud riding. Usage of rear wind protection is recommended.
---	--

Provent Windshield	Maverick X3, Maverick X3 MAX	715005277
	<ul style="list-style-type: none"> • High-impact-resistant Quantum hardcoated polycarbonate full windshield. • Controllable vents to manage air flow. • Optimal performance with full cab enclosure. • Channels air into the cabin, defogs windshield, fully closes to eliminate air flow. • One upper vent and one lower vent with pre-filters. • Formed polycarbonate construction for enhanced rigidity. • Provides excellent optical clarity and better abrasion resistance. • Protects driver and passenger from the elements. • Quick and easy tool-less installation or removal. • Not compatible with wiper kits and Wet Sounds Stealth 6 Ultra HD Can-Am Edition Sound Bar. • Upper vent channels air into the cabin. • Lower vents defog windshield. 	

Glass Windshield with Wiper & Washer Kit	Maverick X3, Maverick X3 MAX	715003283
	<ul style="list-style-type: none"> • Complete kit that includes a curved and laminated glass windshield with a single-speed wiper and washer fluid dispenser. • Seals firmly against the cage and protects rider and passenger from the elements. • An ideal way to keep your windshield clear in rain, or while riding through mud and water. • Recommended to use with rear wind protection. 	

Full Windshield	Maverick X3, Maverick X3 MAX	715002907
	<ul style="list-style-type: none"> • High-impact-resistant durable polycarbonate full windshield. • Formed polycarbonate construction for enhanced rigidity. • Formulated to be non-yellowing, non-crazing, non-cracking with excellent UV resistance and optical clarity. • Protects driver and passenger from the elements. • Quick and easy tool-less installation or removal. • Recommended to use with rear wind protection. 	

Full Windshield – Hardcoated	Maverick X3, Maverick X3 MAX	715004417
	<ul style="list-style-type: none"> • High-impact-resistant Quantum hardcoated polycarbonate full windshield. • Formed polycarbonate construction for enhanced rigidity. • Provides excellent optical clarity and better abrasion resistance. • Protects driver and passenger from the elements. • Quick and easy tool-less installation or removal. • Recommended to use with rear wind protection. • Can be used with the Windshield Wiper and Washer Kit (715004762). 	

Windshield Wiper & Washer Kit	Maverick X3, Maverick X3 MAX Fit with Full Windshield Hardcoated (715004417)	715004762
	Maverick X3, Maverick X3 MAX Fit with Glass Windshield (715003281)	715003282

	<ul style="list-style-type: none"> • An ideal way to keep your windshield clear in rain, or while riding through mud and water. • Includes single-speed wiper and washer fluid dispenser. • Wiper mechanism and washer fluid dispenser perfectly concealed within the vehicle. 	
---	---	--

Half Windshield	Maverick X3, Maverick X3 MAX	<input type="checkbox"/> 715002909 • Clear <input type="checkbox"/> 715004291 • Tinted
	<ul style="list-style-type: none"> • High-impact-resistant durable polycarbonate half windshield. • Formed polycarbonate construction for enhanced rigidity. • Formulated to be non-yellowing, non-crazing, non-cracking with excellent UV resistance and optical clarity. • Protects driver and passenger from the elements. • Features reverse angle lip to deflect air flow. • Quick and easy tool-less installation or removal. 	

MIRRORS**Rear Mirror & Camera Monitor**

Maverick X3, Maverick X3 MAX

715004905

- Fully waterproof rear view camera and monitor kit.
- Multiple camera feeds can be seen with the rear view camera, to see what you need.
- Unit replaces stock rear view mirror (screen is integrated in the unit's replacement rear view mirror).
- Camera uses infrared light for night vision capabilities.

Side Mirrors

Maverick X3, Maverick X3 MAX

715004236 •
For stock quarter doors**715005315** •
For aluminum doors

- Rugged cast aluminum mount with black nylon cover.
- Multi-position adjustable ball-joint mounted mirrors.
- Convex optics for a wide viewing angle.
- Spring-loaded pivots let mirrors fold back completely.
- Door mounted.
- Compatible with Upper Soft Door Panels.
- Sold in pairs.

Racing Side Mirrors

Maverick X3, Maverick X3 MAX

715002898

- Race-inspired design features rugged black nylon $\frac{5}{8}$ construction with coated cast-aluminum mount.
- Dual adjustment provides optimal field of view (FOV).
- Multi-position adjustable ball-joint mounted mirrors.
- Flat optics deliver improved distance perception.
- Spring-loaded pivots let mirrors fold back completely.
- Not compatible with Lonestar Racing Light Racks and Upper Soft Door Panels.
- Sold in pairs.

Rally Side Mirrors

Maverick X3, Maverick X3 MAX

715005262

- Sleek design with unique racing style.
- High-quality black molded aluminum for extreme durability.
- 4" (10 cm) convex surface provides a wider field of view and better visibility around the unit.
- Can be installed at any height on the cage A-pillar for optimized rider vision.
- Multi-position adjustable ball-joint-mounted mirrors.
- Spring-loaded pivots let mirrors fold back completely.
- Sold in pairs.
- Not compatible with Glass Windshield.

DOORS

Aluminum Half Doors

Maverick X3, Maverick X3 MAX

715007971 • Front

Maverick X3 MAX

715007972 • Rear

- Lightweight half doors made of formed $\frac{5}{16}$ " (2 mm) thick aluminum.
- Smooth finish.
- Engineered for maximum rigidity and durability.
- Designed for a perfect fit and seamless integration with the vehicle's lines.
- Contoured with a thick seal for better protection from the elements.
- Easy installation using the standard door frame.
- Includes the easy-to-operate Deluxe Door Handles.
- Compatible with the Upper Soft Door Panels, the Window Nets and Upper Door Storage Bags.
- Not compatible with the Lower Door Panel Storage Bags.
- Sold in pairs.

Deluxe Door Handles	Maverick X3, Maverick X3 MAX	715004758 • Front
	Maverick X3 MAX	715004860 • Rear

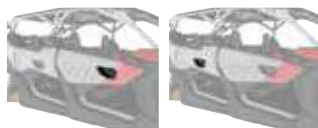

- Convert the standard door straps into easy-to-access door handles.
- Include inside and outside handles for each door.
- Greatly facilitate door opening.
- Standard on accessory Aluminum Half Doors.
- Sold in pairs.

Lower Door Panels	Maverick X3, Maverick X3 MAX	715002903 • Front
		715003751 • Rear

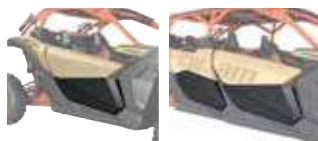

- Robust injection-molded polypropylene construction designed to match vehicle.
- Extend stock doors at bottom to protect and seal cab area.
- A great-looking add-on.
- Easy and quick installation.
- Sold in pairs.
- Rear Lower Door Panels sold separately.

DOORS & REAR WIND PROTECTION

Window Nets	Maverick X3	715006693 • Front
	Maverick X3 MAX	715004694 • Front
	Maverick X3 MAX	715006700 • Rear



- Window mesh screen for added protection from wind.
- Can be easily lowered in seconds.
- Sold in pairs.
- Not compatible with Can-Am Audio Roof.

Upper Soft Door Panels	Maverick X3	715008091 • 2 doors
	Maverick X3 MAX	715008092 • 4 doors



- Weather-resistant panels reinforced with aluminum frame offer good protection from the elements.
- Extend stock quarter doors at the top.
- Made of heavy-duty UV-resistant solution-dyed polyester canvas for excellent resistance to tear and abrasion.
- Zip-down windows made of laminated polished vinyl material for added ventilation.
- To be combined with the Lower Door Panels to obtain complete door kits for your vehicle.
- Not compatible with Racing Side Mirrors and Can-Am Audio Roof.

Rear Wind Screen	Maverick X3, Maverick X3 MAX (except X mr models)	715006701
-------------------------	--	------------------



- Full rear mesh screen reduces windshield backdraft for added cabin comfort.
- Installs quickly and easily on roll cage.
- Large white Can-Am logo on black mesh.

Rear Polycarbonate Window	Maverick X3, Maverick X3 MAX (except X mr models)	715006387
----------------------------------	--	------------------



- High-impact-resistant polycarbonate window.
- Blocks windshield backdraft or dust and rain from entering for added cabin comfort.
- Quick and easy tool-less installation.
- Ready for MTX Audio System Rear Speakers.

Soft Rear Window	Maverick X3, Maverick X3 MAX (except X mr models)	715006702
-------------------------	--	------------------



- Clear, flexible window made from transparent vinyl.
- Resists cold-cracking to -4°F (-20 °C).
- Ideal for preventing backdraft of dust or rain in harsh environments.
- Quick tool-less installation.

HMWPE SKID PLATES

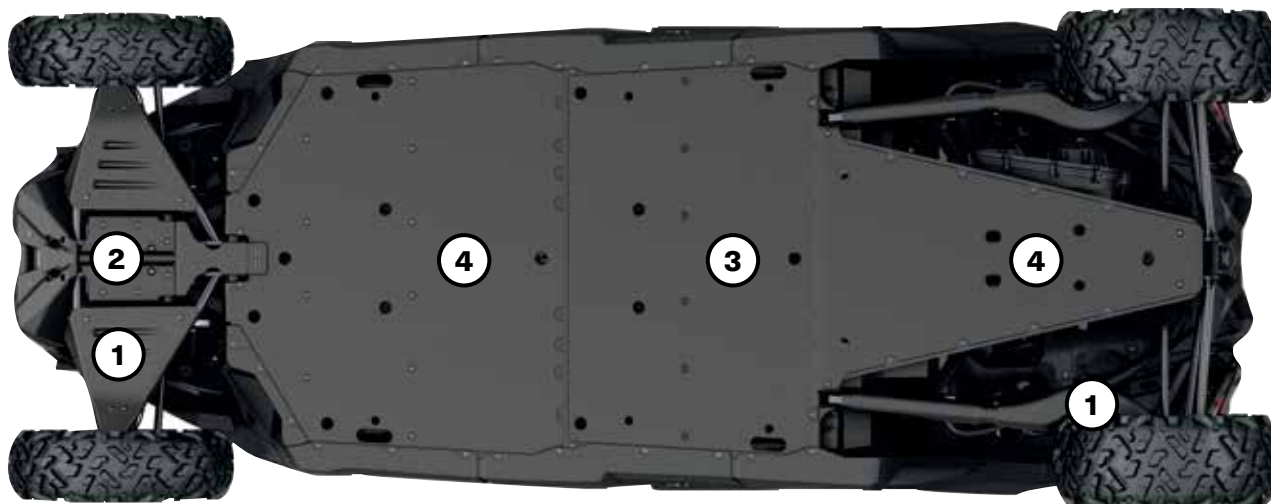

Our Plastic Plates glide smoothly and silently over obstacles, offering great protection in rough terrain. Made of abrasion-resistant thermoformed $\frac{3}{8}$ " (10 mm) thick High Molecular Weight Polyethylene (HMWPE).

- Lighter than aluminum.
- Superior stress crack resistance.
- High-impact strength.

	MAVERICK X3 64" MODELS	MAVERICK X3 MAX 64" MODELS	MAVERICK X3, MAVERICK X3 MAX 72" MODELS (EXCEPT BASE MODELS)	MAVERICK X3 BASE 72" MODELS	MAVERICK X3 MAX BASE 72" MODELS
HMWPE SKID PLATES ARE STANDARD ON MAVERICK X3 X rc MODELS.					
HMWPE Skid Plate Protection Kit	715003713	71500374	715003718	715006767	715006769
① HMWPE Front A-Arm and Trailing Arm Protectors	715002905	715002905	715003552	715003552	715003552
② HMWPE Front Skid Plate	715003933	715003933	715003933	715003933	715003933
③ HMWPE Central Skid Plate	—	715003731	Standard on X rc models only	—	715003731
④ HMWPE Underbelly Plate	715004904	715004904	Standard on X rc models only	715004904	715004904

BUMPERS & GUARDS

BUMPERS

Front Pre-Runner Bumper

Maverick X3, Maverick X3 MAX

- **715002878** • Black
- **715003433** • Can-Am Red



- Made of 1.5" (3.8 cm) diameter steel tubing with a 1/8" (3 mm) aluminum plate for extra durability.
- Inside and outside anti-corrosion coating with durable powder coat finish.
- Added heavy-duty protection in extreme driving conditions.
- Integrated winch mounting plate and mount points for lights.

Rear Pre-Runner Bumper

Maverick X3, Maverick X3 MAX

- **715002880** • Black
- **715003436** • Can-Am Red



- Extra-durable 1.5" (3.8 cm) diameter steel tubing with a 1/8" (3 mm) aluminum plate.
- Inside and outside anti-corrosion coating with durable powder coat finish.
- Protects vehicle bodywork and exhaust system.
- Rear Receiver Hitch compatible.
- Required for installation of the Rear Cage Extension.

Dune Front Bumper

Maverick X3, Maverick X3 MAX

- **715002961** • Black
- **715003432** • Can-Am Red



- Made of 1.5" (3.8 cm) diameter aluminum tubing with a 1/8" (3 mm) aluminum plate.
- Inside and outside anti-corrosion coating with durable powder coat finish.
- Provides added protection without sacrificing the agility and performance advantages of a lighter weight design.
- Features a more pronounced attack angle and integrated mounting points for lights.
- Not winch compatible.

Dune Rear Bumper

Maverick X3, Maverick X3 MAX

- **715002962** • Black
- **715003437** • Can-Am Red



- Made of 1.5" (3.8 cm) diameter aluminum tubing with a 1/8" (3 mm) aluminum plate.
- Inside and outside anti-corrosion coating with durable powder coat finish.
- Provides added protection without sacrificing the agility and performance advantages of a lighter weight design.
- Protects vehicle bodywork and exhaust system.
- Rear hitch compatible.
- Not compatible with Rear Cage Extension and Lonestar Racing Spare Tyre Holder.

X rc/X mr Front Bumper

Maverick X3, Maverick X3 MAX

- **715004741** • Sunburst Yellow
- **715004742** • Octane Blue
- **715004788** • Black



- Made of 1.5" (3.8 cm) diameter steel tubing with a 1/8" (3 mm) aluminum plate.
- Inside and outside anti-corrosion coating with durable powder coat finish on steel tubing.
- Offers all the essential features required for technical driving: Low front-end protection, support base for winch installation and integrated tow hook.
- Standard on Maverick X3 X rc and X mr models.
- Not compatible with winches with steel cable.

Lonestar Racing Front Bumper

Maverick X3, Maverick X3 MAX
(not compatible X mr and X rc models,
and models equipped with Smart-Shox)
Maverick X3, Maverick X3 MAX

- **715005510** • Hyper Silver
- **715005509** • Black
- **715004161** • Can-Am Red



- Made of 1.5" (3.8 cm) diameter steel tubing with durable powder coat finish and a 1/8" (3 mm) thick aluminum plate for added vehicle-front protection in extreme driving conditions.
- Sleek styling enhances the vehicle's race-inspired look.
- Not winch compatible.
- Not compatible with 10" (25 cm) Baja Designs OnX6 LED Light Bar.

Lonestar Racing Rear Bumper

Maverick X3, Maverick X3 MAX

- **715005512** • Hyper Silver
- **715005511** • Black
- **715004162** • Can-Am Red



- Made of 1.5" (3.8 cm) diameter steel tubing with durable powder coat finish.
- Provides additional vehicle-rear bodywork and exhaust system protection in extreme driving conditions.
- Sleek styling enhances the vehicle's race-inspired look.
- Compatible with Lonestar Racing Spare Tyre Holder.
- Not hitch compatible.

S3⁺ Front Bumper

Maverick X3, Maverick X3 MAX

- **715004867** • Black
- **715005231** • Can-Am Red



- Made of 1.5" (3.8 cm) diameter steel tubing with a 1/8" (3 mm) aluminum plate for extra durability.
- Inside and outside anti-corrosion coating with durable powder coat finish.
- Added heavy-duty protection in extreme driving conditions.
- Integrated winch support plate and mount points for lights.
- Hook support anchor allows you to keep the winch hook within easy reach when riding in deep mud.
- "S3 for Can-Am" branded.
- Winch not included.

S3 Rear Bumper

Maverick X3, Maverick X3 MAX

- **715004869** • Black
- **715005232** • Can-Am Red



- Made of extra-durable 1.5" (3.8 cm) diameter steel tubing.
- Inside and outside anti-corrosion coating with durable powder coat finish.
- Added heavy-duty protection in extreme driving conditions – protects vehicle bodywork and exhaust system.
- Permits installation of a winch at a higher location to improve accessibility in muddy conditions.
- "S3 for Can-Am" branded.
- Engineered to sustain heavy winch loads without damaging the vehicle's frame.
- Compatible with Can-Am HD and WARN VRX winches – rear winch harness 715006007 is required to install a winch on the bumper.
- Includes a robust recovery hook to facilitate vehicle recovery.
- Winch not included.
- Not EC compliant.

ROCK SLIDERS

Rock Sliders

Maverick X3 (except X rc)

Maverick X3 MAX

- **715002963** • Black
- **715003438** • Can-Am Red
- **715003730** • Black
- **715003888** • Can-Am Red



- Made of heavy-duty 1.5" (3.8 cm) diameter steel tubing.
- Inside and outside anti-corrosion coating with durable powder coat finish.
- Protect vehicle's sides and undercarriage against large obstacles.
- Support plate adds rigidity and style.
- Sold in pairs.

X rc UHMWPE Rock Sliders

Maverick X3

715004730



- Robust 1/4" (6 mm) UHMWPE construction.
- Include lower body panels and brackets for installation.
- Protect vehicle's sides and undercarriage against large obstacles.
- Lodge tight up against vehicle body for better clearance from obstacles.
- Slide smoothly over obstacles.
- Sold in pairs.

Lonestar Racing Rock Sliders

Maverick X3

Maverick X3 MAX

- 715005514 • Hyper Silver
- 715005513 • Black
- 715004165 • Can-Am Red
- 715005518 • Hyper Silver
- 715005517 • Black
- 715004343 • Can-Am Red



- Made of 1.5" (3.8 cm) diameter steel tubing with durable powder coat finish filled with 1/8" (3 mm) aluminum plate.
- Protects vehicle sides from large obstacles.
- Sleek styling enhances the vehicle's race-inspired look.
- "Lonestar Racing for Can-Am" branded.
- Sold in pairs.
- Not compatible with X rc models.

INTRUSION BARS

Front Intrusion Bar

Maverick X3, Maverick X3 MAX

- 715002889 • Black
- 715003435 • Can-Am Red



- Matches vehicle styling.
- Inside and outside anti-corrosion coating with durable powder coat finish steel intrusion bar.
- Tube design reduces obstructed lines of sight and blind spots for better visibility.
- Not compatible with windshields and Lonestar Racing Aluminum Roof.

Lonestar Racing Front Intrusion Bar

Maverick X3, Maverick X3 MAX

- 715006342 • Hyper Silver
- 715003916 • Black
- 715004163 • Can-Am Red



- Made of 1.5" (3.8 cm) diameter steel tubing with durable powder coat finish.
- Enhances the racing look of the vehicle.
- Compatible with Lonestar Racing Aluminum Roof only.
- Not compatible with windshields.

Lonestar Racing Rear Intrusion Bar

Maverick X3 (except X mr models), Maverick X3 MAX

- 715006343 • Hyper Silver
- 715003918 • Black
- 715004164 • Can-Am Red



- Made of 1.5" (3.8 cm) diameter steel tubing with durable powder coat finish.
- Sleek styling enhances the vehicle's race-inspired look.
- Required for the installation of the Lonestar Racing Spare Tyre Holder.
- Not compatible with LinQ mounted accessories and Pre-Filter in the cargo bed.

OTHER ACCESSORIES

Fender Flares

Maverick X3, Maverick X3 MAX

715002973



- Extended fender flares made from injection-molded polypropylene.
- Keep mud and debris out of vehicle.
- Designed for quick and easy installation.
- Include front and rear extensions and mounting hardware.

Lonestar Racing Spare Tyre Holder

Maverick X3, Maverick X3 MAX
(except X mr models)

■ **715006344** • Hyper Silver

■ **715003922** • Black

■ **715004166** • Can-Am Red



- Made of 1.5" (3.8 cm) diameter steel tubing with durable powder coat finish.
- Adjustable height to fit Can-Am tyres up to 30 in.
- Requires Lonestar Racing Rear Bumper and Lonestar Racing Rear Intrusion Bar for installation.
- Cannot hold the Pro Armor Quickshot Wheel Jack and Off-Road Screw Jack.
- Wheel not included.
- Not compatible with the S&B Particle Separator and LinQ accessories intended for the rear of the vehicle.

Lonestar Racing Number Plate Holder

Maverick X3, Maverick X3 MAX

715003943



- Includes a pair of sturdy aluminum number plates that mount on either side of the vehicle rear.
- Not compatible with LinQ Pivoting Rack.
- Numbered decals are available through SCS Unlimited.
- Styling enhances the vehicle's race-inspired look while adding a personal touch.
- Black background.

Rear Cage Extension

Maverick X3 (except X mr models), Maverick X3 MAX

■ **715008298** • Black

■ **715008299** • Can-Am Red



- Durable 1.5" (3.8 cm) diameter steel tubing.
- Inside and outside anti-corrosion coating with durable powder coat finish.
- Allows holding a spare tyre in place (wheel not included).
- Custom tie-down strap for fast tyre installation or removal.
- Rear Pre-Runner Bumper required for installation.
- Not compatible with LinQ Pivoting Rack, cargo boxes (except LinQ 20 gal (73 L)
- Deluxe Modular Bag) and Lonestar Racing roofs.

S3 Rear Pull Plate

Maverick X3, Maverick X3 MAX

■ **715004870** • Black

■ **715005233** • Can-Am Red



- Offers a solid place to hook onto in case towing is needed.
- Allows you to attach most straps and hooks.
- "S3 for Can-Am" branded.

SEAT ACCESSORIES

4-Point Harness

Maverick X3, Maverick X3 MAX

715008033 • Driver**715008034** • Passenger

- Exclusive controlled decelerator technology (patent pending) absorbs additional energy in case of accident.
- Designed to offer maximum riding comfort.
- Easy one-click latch and release.
- Patent pending.
- Not EC compliant.

Retractable 4-Point Harness

Maverick X3, Maverick X3 MAX

715005021 • Driver**715005022** • Passenger

- Convenient harness allows you to move freely in your seat, and at the same time fully benefit from the extra support given by the 4-point attachments.
- Makes it easier to buckle up and requires fewer adjustments when switching passenger or driver.
- Retractor Protector (707900653) is required for installation on front seats of MAX models.
- Compatible with rear passenger seats on MAX models.
- Standard on select Maverick X3 models.

Retractor Protector

(Not illustrated)

Maverick X3 MAX

707900653

- Protective pad required for the installation of the Retractable 4-Point Harness on front seat of MAX models.
- Protects the passengers from the retractor mechanism.
- Sold individually.

Seat Belt Shoulder Pads

Maverick X3, Maverick X3 MAX

715002894

- Provide additional riding comfort by preventing seat belt from rubbing on neck and shoulder.
- Fit with stock 3-point seat belts and 4 point harness.
- Easy Velcro installation.
- Can-Am branded.
- Sold in pairs for driver and passenger.

LinQ: EASY ON, EASY OFF CARGO

MAVERICK'S LinQ ACCESSORIES

- No tools needed: Quickly install and remove accessories by hand
- Equip your Can-Am for specialized tasks in no time
- Sturdy mounting system that holds up to the roughest terrain

MOUNTING LOCATION AND REQUIREMENTS

Standard
LinQ Rack

LinQ
Pivoting Rack
715008295/715008296

Adventure
Roof Rack
715003868/715006225

LinQ ACCESSORIES WITH 16" BASE

- LinQ anchors mounted 16 inches apart, center-to-center.
- Lower loading capacity than the LinQ with 36" base accessories.
- Can be used on Can-Am ATV and SSV vehicles, Can-Am Spyder and Ryker vehicles, Sea-Doo watercraft and Ski-Doo snowmobiles.

LinQ 4.2 Gal Cooler
295100698 • Gray
219400964 • Black

LinQ Base Installation Kit
715008125

LinQ Tool Kit
715006829

No further requirements

LinQ Tool Box
715008111

LinQ SR 5.5 Gal (21 L) Bag
860202449

LinQ Anchor Adapter Kit
715004960

LinQ Anchor Adapter Kit
715004960

LinQ Base Installation Kit
715008125

LinQ 4.5 Gal (17 L) Sport Bag
860202447

LinQ Modular Box
715005494 • (10 L)
715007112 • (20 L)
715006830 • (30 L)

No further requirements

LinQ Dry Bag
715008110

LinQ Base Installation Kit
715008125

LinQ ACCESSORIES WITH 36" BASE

- Mount on LinQ racks often used by Can-Am ORV vehicles.
- Higher loading capacity than the LinQ with 16" base accessories.
- Usage is limited to Can-Am ORV vehicles.

LinQ 12 Gal (45 L) Cargo Box
715003879

No Compatibility

LinQ 23 Gal (86 L) Trunk Box
715004923

No further requirements
*Not compatible if the LinQ
Pivoting Rack is installed.

LinQ 32 Gal (121 L) Trunk Box
715001748

LinQ 11.5 Gal (43 L) Audio Cargo Box
715003018

No further requirements

No further requirements

No Compatibility

LinQ 8 Gal (30 L) Cooler Box
715004778 • Black
715004698 • Gray

LinQ Premium Storage Bag by OGIO†
715002923 • Black
715003248 • Camo

No further requirements

LinQ Heavy Duty Basket
715001215

No further requirements

LinQ Low Profile Basket
715004282

LinQ HOLDERS

LinQ Gear Grips
715005340

No further requirements

No further requirements

Side wall installation
LinQ Adaptors
715003058

LinQ Tool Holder
715007358

LinQ ACCESSORIES WITH 16" BASE

ESSENTIAL LinQ Tool Kit	Maverick X3, Maverick X3 MAX	715006829
--------------------------------	------------------------------	------------------



- Includes:
 - Cutter pliers.
 - Long-nose pliers.
 - Locking pliers.
 - Ratchet wrench 3/8" drive.
 - 6" ratchet extension.
 - Integrated CVT belt storage location (belt not included).
 - Long-socket 19 mm 3/8" drive - 6pts.
 - Socket 18 mm 3/8" drive.
 - Long-socket 17 mm 3/8" drive - 6pts.
 - Socket 15 mm 3/8" drive.
 - Socket 13 mm 3/8" drive.
 - Socket 10 mm 3/8" drive.
 - Socket 8 mm 3/8" drive.
 - Combined wrench 19 mm.
 - Combined wrench 18 mm.
 - Combined wrench 15 mm.
 - Combined wrench 13 mm.
 - Combined wrench 10 mm.
 - Combined wrench 8 mm.
 - Socket torx T30 3/8" drive.
 - Socket torx T20 3/8" drive.
 - Breaker bar 3/8" drive.
 - See table for installation location and requirements.

LinQ Modular Box	Maverick X3, Maverick X3 MAX	715005494 • (10 L) 715007112 • (20 L) 715006830 • (30 L)
-------------------------	------------------------------	---



- Modular LinQ cargo boxes with 10 L (2.6 gal) capacity.
- Allows stacking of other modular boxes to always have the right gear accessible.
- Always have the right box size to fit everything.
- Can be installed on any LinQ base with a 16" width.
- See table for installation location and requirements.

Thermal Insert for LinQ Modular Box (10 L)	Maverick X3, Maverick X3 MAX	219401110
---	------------------------------	------------------



- Insulated liner.
- Fits very well in the LinQ Modular Box (10 L).
- Can contain five 473 ml cans or six 355 ml cans.

LinQ Tool Box	Maverick X3, Maverick X3 MAX	715008111
----------------------	------------------------------	------------------



- High precision injected HDPE construction provides rigidity and durability.
- 5 gal (19 L) maximum capacity.
- Weather-resistant, sealed and lockable cover.
- Easy one-second on/off tool-less system.
- All the benefits of LinQ—simple, fast and secure.
- Requires LinQ Base Installation Kit (715008125).
- See table for installation location and requirements.

LinQ 4.2 Gal (16 L) Cooler	Maverick X3, Maverick X3 MAX	■ 219400964 • Black ■ 295100698 • Gray
-----------------------------------	------------------------------	--



- All the benefits of LinQ—simple, fast and secure.
- Rotomolded construction for exceptional rigidity and durability.
- Premium-quality foam insulation for optimal ice retention.
- Uses LinQ mounting system (Patent US 8777531 and US 8875830).
- Easy one-second on/off tool-less system.
- See table for installation location and requirements.

LinQ 4.5 Gal (17 L) Sport Bag	Maverick X3, Maverick X3 MAX	860202447
--------------------------------------	------------------------------	------------------



- 17-liter (4.5 US gallon, 1,037 cu. in.) capacity.
- Rigid bottom, semi-rigid top.
- Requires LinQ Base Installation Kit (715008125).
- See table for installation location and requirements.

SR 5.5 Gal (21 L) LinQ Bag	Maverick X3, Maverick X3 MAX	860202449
-----------------------------------	------------------------------	------------------



- All the benefits of LinQ—simple, fast and secure.
- Semi-rigid expandable bag.
- 5.5 gal (21 L) capacity.
- Utilizes LinQ mounting system (Patent US 8777531 and US 8875830).
- Easy one-second on/off tool-less system. Requires LinQ Base Installation Kit (715008125).
- Adventure Roof Rack required (Maverick X3 MAX).
- LinQ Anchor Adaptor Kit required.

LinQ Dry Bag

Maverick X3, Maverick X3 MAX

715008110



- Fully waterproof roll-top dry bag will securely store and confine your equipment.
- LinQ mounted using heavy-duty rigid plastic base.
- High capacity storage solution (40 L).
- Bottom foam liner for additional equipment protection.
- Integrated handle for easy transportation on/off the vehicle.
- Requires LinQ Base Installation Kit (715008125).
- See table for installation location and requirements.

LinQ ACCESSORIES WITH 36" BASE

LinQ 12 Gal (45 L) Cargo Box

Maverick X3, Maverick X3 MAX

715003879



- LinQ mounted for easy-on, easy-off installation.
- Holds cargo safely and securely while riding.
- See table for installation location and requirements.

LinQ 23 Gal (86 L) Trunk Box

Maverick X3 (except X mr models), Maverick X3 MAX

715004923



- LinQ mounted for easy-on, easy-off installation.
- Holds cargo safely and securely while riding.
- See table for installation location and requirements.

LinQ 32 Gal (121 L) Trunk Box

Maverick X3 (except X mr models), Maverick X3 MAX

715001748 • (No rear tail light)



- Equipped with the LinQ System, the rear trunk box plugs in and out in seconds.
- 32 gal (121 L) load capacity with unobstructed space to maximize storage room and access to the trunk's interior.
- Made of injection-molded polyethylene, double walled in critical areas.
- The fully sealed lid protects your belongings from dust, moisture and the elements.
- No rear tail light.
- Trunk Box Panels available in many colors to match your vehicle (sold separately).
- See table for installation location and requirements.

LinQ 32 Gal (121 L) Trunk Box Panels

Maverick X3, Maverick X3 MAX



- Color panels to match the LinQ 32 gal (121 L) LinQ Trunk Box to your vehicle.

LinQ 32 Gal (121 L) Trunk Box Panels
(Not Illustrated)

EUROPEAN VERSION
(EC compliant)

- **715001397** • Black
- **715001398** • Yellow
- **715002482** • Light Gray
- **715002483** • White

- **715006121** • Can-Am Red
- **715006122** • Manta Green
- **715006123** • Orange Crush
- **715006124** • Viper Red

- Color panels to match the LinQ 32 gal (121 L) LinQ Trunk Box to your vehicle.
- No rear tail light

LinQ 8 Gal (30 L) Cooler Box

Maverick X3, Maverick X3 MAX

- **715004778** • Black
- **715004698** • Gray



- LinQ mounted for easy-on, easy-off installation.
- Rotomolded construction provides exceptional rigidity and durability.
- Premium-quality foam insulation for optimal ice retention.
- Integrated, fully removable compartment protects food.
- Robust rubber latches keep the cover tightly closed.
- Weather-resistant.
- Convenient drain plug.
- See table for installation location and requirements.

LinQ 11.5 Gal (43 L) Audio Cargo Box

Maverick X3, Maverick X3 MAX

715003018

- An affordable and quick solution for adding music and storage to your next ride.
- The rear installation does not use up any cab space and allows easy listening at an average speed.
- Mounts on/off easily to hold/carry cargo safely and securely.
- Backlit control panel perfect for night riding.
- Water-resistant speakers.
- The Bluetooth[®] enabled receiver and 6.5" (16.5 cm) speakers are smartly concealed and integrated in the cover.
- Automatic shut-off function protects your battery by turning the system off after 10 minutes of inactivity.
- See table for installation location and requirements.

LinQ Heavy-Duty Basket

Maverick X3, Maverick X3 MAX

715001215

- Made of high-strength, low-alloy steel.
- LinQ mount for easy-on, easy-off installation.
- See table for installation location and requirements.

LinQ Premium Storage Bag by OGIO

Maverick X3, Maverick X3 MAX

■ **715002923** • Black
 ■ **715003248** • Mossy Oak Break-Up Country Camo



- Tool-less installation and removal thanks to the LinQ system.
- 17.2 gal (65 L) capacity semi-rigid cargo bag ideal for carrying anything you need on your vehicle.
- Buckle and elastic closure with a rubber seal that protects dust from entering the bag.
- 3-section lid for partial or full access to your bag.
- Inside separators for optimal bag organization.
- See table for installation location and requirements.

LinQ Low Profile Basket

Maverick X3, Maverick X3 MAX

715004282

- Low profile, open basket increases cargo space.
- Perfect for easy access to tools, rope, winch and plow accessories.
- Multiple bungee cord and tie-down anchor points.
- Made of impact-resistant injected polypropylene.
- See table for installation location and requirements.

LinQ HOLDERS**LinQ Tool Holder**

Maverick X3, Maverick X3 MAX

715007358

- Ultra-versatile tool holder.
- Convenient swivel-latch allows tools to be stored in any orientation.
- Sold in pairs.

LinQ Gear Grips

Maverick X3, Maverick X3 MAX

715005340

- Durable and flexible grips provide a custom fit for a variety of items from 1" to 4" (2.5 cm to 10 cm) in diameter.
- Heavy-duty design for carrying bows, fishing poles, rakes, farm tools and more.
- Quick-release button opens grip quickly for easy access to gear.
- Heavy-duty base system built for the toughest adventures.
- Make transporting your tools a snap by combining the LinQ Gear Grips with the LinQ System.
- 360° orientation.
- Sold in pairs.

LinQ MOUNTING

LinQ Anchor Adapter Kit

Maverick X3, Maverick X3 MAX

715004960



- Allows the installation of LinQ accessories with 16" base on LinQ racks.
- Tool-less installation and removal.
- LinQ pivoting rack is required for installation.

LinQ Base Installation Kit

Maverick X3, Maverick X3 MAX

715008125



- Allows installation of compatible LinQ accessories.
- Included: 2 LinQ Cargo bases and hardware.

Tube LinQ Adapter

Maverick X3, Maverick X3 MAX

715004292



- Cage mounted LinQ receiver.
- Included in the LinQ Pivoting Rack assembly.
- Allows the installation of single LinQ mounted accessory.
- Diameter: 1.85" (47 mm).

LinQ Lock

Maverick X3, Maverick X3 MAX

860201968



- Simple way to lock most LinQ accessories in place.
- Retrofits most LinQ accessories.
- A cover protects the lock from the elements.
- Not compatible with Tool Holder or LinQ Gear Grips.
- Pack of one.
- Comes with two keys.

LinQ Replacement Part

Maverick X3, Maverick X3 MAX

715001707



- Unique mounting fastener usable on any LinQ System accessory.
- Tool-less installation and removal.
- Sold in pairs.

LinQ Adaptor

(Not illustrated)

Maverick X3 MAX

715003058

- Allows the installation of the LinQ Tool Holder on the Adventure Roof Rack.
- Sold in pack of 4.

Cargo Box Net

Maverick X3, Maverick X3 MAX

715001371



- Solid net designed to secure and ensure the compact confinement of your Adventure Roof Rack.

Spare Tyre Ratchet Tie-Downs

Maverick X3, Maverick X3 MAX

280000955



- 3-way ratcheting tie-down strap with loop ends.
- Designed to securely hold spare tyres on accessories equipped with integrated spare tyre attachment points.
- Adjustable to accommodate most common UTV tyre sizes.
- Ratchet and junction ring made of durable zinc-plated steel.
- Required for spare tyre attachment on Adventure Roof Rack.

RACKS & STORAGE

RACKS

LinQ Pivoting Rack

Maverick X3 (except X mr models), Maverick X3 MAX

■ **715008295** • Black

■ **715008296** • Can-Am Red



- LinQ latched rack allows for extra LinQ mounted accessories or for carrying a spare tyre (tyre not included).
- Includes custom tie-down strap for fast spare tyre installation or removal (tyre not included).
- Gas-cylinder pivot action, locks in the raised position.
- Trunk Boxes over 20 gal (74 L) do not fit on the vehicle when the rack is installed.
- Not compatible with Rear Intrusion Bars, Rear Cage Extension and Lonestar Racing Aluminum Roofs.

Adventure Roof Rack

Maverick X3

715006225

Maverick X3 MAX

715003868



- Ideal cargo solution for packing everything you need to live your Off-Road experience fully and completely.
- Built with lightweight 1.25" (3.2 cm) diameter steel tubing.
- Integrated mounting points for lights can hold up to eight pod-type LED lights (six front and two back) or a 40" (102 cm) LED bar (front).
- Features anchor points for spare-tyre attachment.
- LinQ anchor on both sides.
- Spare Tyre Tie-Downs sold separately.
- Add the Cargo Box Net to secure and confine your cargo in the rack.
- Loads up to 75 lb (34 kg).

STORAGE

Shoulder Storage Bag

Maverick X3 (except X mr models),
Maverick X3 MAX (rear only)

715004277



- Bag attaches in unused space between the seats to increase your vehicle's cargo capacity.
- Installs between the rear seats only on MAX models.

Front Shoulder Storage Bag

Maverick X3 MAX

715004888



- Opens on each side so that both front and rear passengers can access the bag's content.
- Installs between the driver and passenger seats on MAX models.

Overhead Storage Bag

Maverick X3, Maverick X3 MAX

715004275



- Weather-resistant bag, holds your gear safely and securely while riding.
- Makes smart use of your overhead space to increase your vehicle's cargo capacity by 2.6 gal (10 L).
- Semi-rigid construction renders it flexible enough to fit odd-shaped loads.
- Touchscreen-compatible clear front pocket allows for easy access to your smartphone.
- Not compatible with the Bimini Roof.

Upper Door Storage Bags

Maverick X3, Maverick X3 MAX

715004276



- Weather-resistant, they'll hold your gear safely and securely while riding.
- Bags attach on stock quarter doors to increase your vehicle's cargo space.
- Each bag is designed as a 1.3 gal (5 L) capacity pocket also equipped with inner netting compartments.
- Semi-rigid construction renders them flexible enough to fit odd-shaped loads.
- Sold in pairs.

Lower Door Panel Storage Bags

Maverick X3, Maverick X3 MAX

715004355



- Weather-resistant, they'll hold your gear safely and securely while riding.
- Bags attach on Lower Door Panels to increase your vehicle's cargo space.
- Each bag is designed as a 1.6 gal (6 L) capacity pocket also equipped with inner netting compartments.
- Semi-rigid construction renders them flexible enough to fit odd-shaped loads.
- Sold in pairs.
- Not compatible with aluminum doors and Off-Road Screw Jack.
- Lower add-on doors required for installation.

Soft Storage Bag

Maverick X3, Maverick X3 MAX

715003759



- 11.8 gal (45 L) capacity soft cargo bag designed with vehicle's rear in mind to maximize potential storage.
- 3 sections.
- Weatherproof.

Storage 2.6 Gal (10 L) Bag

Maverick X3, Maverick X3 MAX

269502121



- Roll-top dry bag for fully protecting your cargo from the elements.

LIGHTS

1 CHOOSE YOUR MOUNT POINT		2 CHOOSE YOUR LIGHTS								
		BAJA DESIGNS' LIGHTS				CAN-AM LIGHTS				
		10" (25 cm) LED light bar	40" (102 cm) Baja Designs OnX6 Arc LED Light Bar	XL Sport LED lights (sold in pairs)	XL80 LED lights (sold in pairs)	10" double stacked LED bar	15" double stacked LED bar	39" double stacked LED bar	4" round LED lights (sold in pairs)	3.5" spot or flood LED lights (sold in pairs)
		Consult p. 36 information on Baja Designs lights.				Consult p. 37 for information on Can-Am lights.				
Front Pre-Runner or Dune Bumpers	710006819	710006818	710006821	710005041	715002933	715002934 (Not compatible with Pre-Runner Bumper)			715002935 (4" Round), 715003665 (3.5" Flood) or 715003666 (3.5" Spot)	
	+ 715007049 (Power Cable)	+ 715007117 (Power Cable)	+ 715002884 (Power Cable)	+ 715007049 (Power Cable)	+ 715003417 (Power Cable)		+ 715003417 (Power Cable)			+ 715003417 (Power Cable)
Lonestar Racing Front Bumper	NA	710006818 + 715007117 (Power Cable)	710006821 + 715002884 (Power Cable)	710005041 + 715007049 (Power Cable)					715002935 (4" Round), 715003665 (3.5" Flood) or 715003666 (3.5" Spot) + 715003417 (Power Cable)	
Light Support Bar or Adventure Roof Rack	710006819 + 715007049 (Power Cable)	710006818 + 715007117 (Power Cable)	710006821 + 715002884 (Power Cable)	710005041 + 715007049 (Power Cable)	715002933 + 715003417 (Power Cable)	715002934 + 715003417 (Power Cable)	710004007 + 715005822 (Light Mounting Kit)		715002935 (4" Round), 715003665 (3.5" Flood) or 715003666 (3.5" Spot) + 715003417 (Power Cable)	
Lonestar Racing 40" (102 cm) LED Light Bar Rack	NA	710006818 + 715007117 (Power Cable)	NA	NA	NA	NA	NA	NA	NA	NA
Lonestar Racing Light Rack	NA	NA	710006821 + 715002884 (Power Cable)	710005041 + 715007049 (Power Cable)	NA	NA	NA	NA	NA	NA
3 ORDER		ORDER ALL PART NUMBERS IN INTERSECTING BOX								
		*Note: When installing more than one light kit, additional light power cable or mounting kit is required.								

*All lights are intended for Off-Road use only.

Baja Designs Light Power Cable
(Not illustrated)

Maverick X3, Maverick X3 MAX

- 715003417**
- 715007049**
- 715002884**
- 715007117**

- Required for installation of Baja Designs LED lights onto roof or bumper.
- 10" (25 cm) Baja Designs OnX6 LED Bars and Baja Designs XL80 LED Lights (715007049).
- Baja Designs XL Sport LED Lights and Baja Designs Squadron Sport LED Lights (715002884).
- 40" (102 cm) Arc LED Light Bar ONX6 (715007117).

40" (102 cm) Baja Designs OnX6 Arc LED Light Bar

Maverick X3, Maverick X3 MAX

710006818

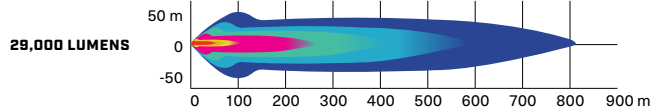

- 252 W light bar producing 29,000 lumens.
- Equipped with 24 Cree XM-L2 LEDs.
- Driving/Combo light pattern for smooth blend of light for both near field applications and distance.

- Designed for installation onto Light Support Bar equipped roofs.
- Requires Light Power Cable and Light Support Bar.

Baja Designs 10" (25 cm) OnX6 LED Light Bar

Maverick X3, Maverick X3 MAX

710006819

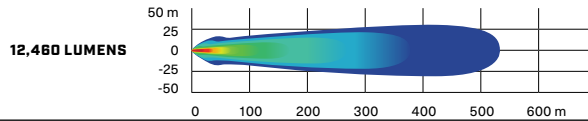

- 108 W light bar producing 12,460 lumens.
- Equipped with 6 Cree XM-L2 LEDs.
- Driving/combo light pattern for smooth blend of light for both near field applications and distance.

- Dual intensity (high/low) settings.
- Requires Baja Designs Light Power Cable.

Baja Designs XL80 LED Lights

Maverick X3, Maverick X3 MAX

710005041

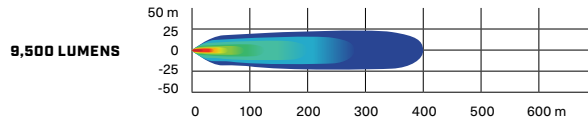

- 80 W per spot producing 9,500 lumens.
- Equipped with 4 Cree XHP50 LEDs per spot.
- Dual intensity (high/low) settings.
- Driving/combo light pattern for smooth blend of light for both near field applications and distance.

- Require Baja Designs Light Power Cable.
- Sold in pairs.
- Dimensions: 4.5" x 4.5" (11.4 cm x 11.4 cm).

Baja Designs Squadron Sport LED Lights

Maverick X3, Maverick X3 MAX

710006820

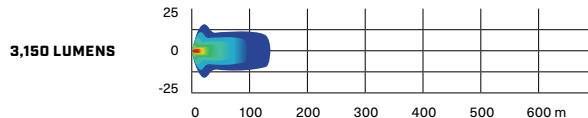

- 26 W per spot producing 3,150 lumens.
- Equipped with 4 Cree XP-G2 LEDs per spot.
- Wide cornering light pattern designed specifically for cornering, dust and/or fog conditions.

- Require Baja Designs Light Power Cable.
- Sold in pairs.
- Dimensions: 3" x 3" (7.6 cm x 7.6 cm).

Baja Designs XL Sport LED Lights

Maverick X3, Maverick X3 MAX

710006821

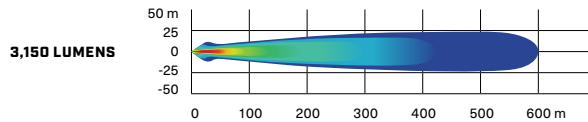

- 26 W per spot producing 3,150 lumens.
- Equipped with 4 Cree XP-G2 LEDs per spot.
- High Speed Spot features a longer and narrower beam focus for illumination farther down.

- Require Baja Designs Light Power Cable.
- Sold in pairs.
- Dimensions: 4.5" x 4.5" (11.4 cm x 11.4 cm).

10" (25 cm) Double Stacked LED Light Bar (60 W)

Maverick X3, Maverick X3 MAX

715002933



5,400 LUMENS

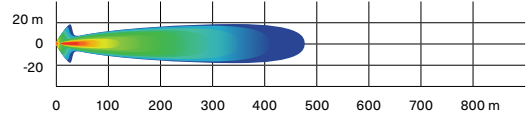

- Equipped with twelve 5 W Cree LEDs.
- 5,400 lumens.
- Packs a big punch for its size.
- Rugged and waterproof.
- Can be installed in stock XT and XT-P bumpers.

- Requires light power cable for installation.
- Lights up to more than 1,500 ft. (460 m) in front of the vehicle and around 65 ft. (20 m) wide on each side.
- EC compliant.

15" (38 cm) Double Stacked LED Light Bar (90 W)

Maverick X3, Maverick X3 MAX

715002934



8,400 LUMENS

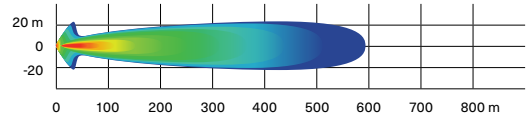

- Equipped with 18 5 W Cree LEDs.
- 8,400 lumens.
- Complements the Light Racks and most bumpers.
- Rugged and waterproof.

- Lights up to more than 1,900 ft. (580 m) in front of the vehicle and around 65 ft. (20 m) wide on each side.
- EC compliant.

39" (99 cm) Double Stacked LED Light Bar (270 W)

Maverick X3, Maverick X3 MAX

715004007



24,300 LUMENS

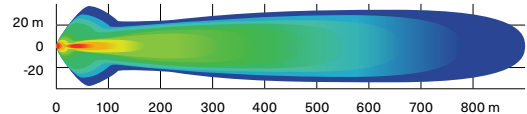

- Equipped with 54 5 W Cree LEDs.
- 24,300 lumens.

- Not compatible with Full Windshield, Flip Windshield and Can-Am Intrusion Bar.
- Lights up to more than 2900 ft. (900 m) in front of the vehicle and around 115 ft. (35 m) wide on each side.

4" (10 cm) Round LED Lights (2 x 25 W)

Maverick X3, Maverick X3 MAX

715002935



1,800 LUMENS

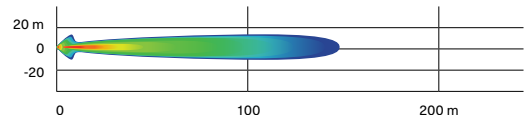

- 25 W LED Spotlights.
- 1,800 lumens.
- Rugged and waterproof.
- Includes basic wiring and switch.

- Can-Am branded grill.
- Requires light power cable.
- Sold in pairs.
- Not EC compliant.

3.5" (9 cm) LED Driving Lights (2 x 14 W)

Maverick X3, Maverick X3 MAX

715003666



1,260 LUMENS

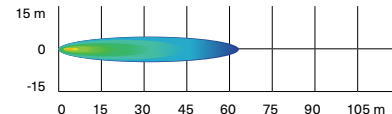

- 14 W LED lights producing 1,260 lumens each.
- Spot lens for a narrow and long light beam spread, ideal when driving at higher speeds.
- Equipped with six high-power LEDs in a heavy-duty die-cast aluminum housing.

- Features two attachment points. If one attachment point fails due to a collision, rotate to the next channel point and remount the light.
- Sold in pairs.
- EC compliant.

3.5" (9 cm) LED Flood Lights (2 x 14 W)

Maverick X3, Maverick X3 MAX

715003665



1,260 LUMENS

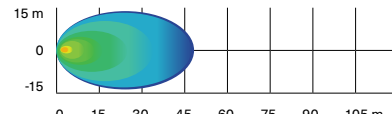

- 14 W LED lights producing 1,260 lumens each.
- Flood lens for a wide light beam spread, ideal for working applications like plowing or cornering. Suitable for dusty or foggy riding conditions.
- Equipped with six high-power LEDs in a heavy-duty die-cast aluminum housing.

- Features two attachment points. If one attachment point fails due to a collision, rotate to the next channel point and remount the light.
- Sold in pairs.
- EC compliant.

Can-Am LED Signature Lights

Maverick X3, Maverick X3 MAX

715003673

- Add style with a more aggressive look.
- Use bright and energy efficient LEDs.
- Do not give additional lighting for driving.

Dome Light

Maverick X3, Maverick X3 MAX

715002455

- LED array integrates perfectly with vehicle.
- Wiring included.
- Can be installed on cage, Sport Roof or All-Terrain Trunk Cover.

Lonestar Racing 40" (102 cm) LED Light Bar Rack

Maverick X3, Maverick X3 MAX

715003920

- Designed for use with 40" (102 cm) Baja Designs OnX6 Arc LED Light Bar.
- Enhances the vehicle's race-inspired look.
- Compatible with Aluminum Roof, Lonestar Racing Aluminum Roof and Sport Roof.
- Not compatible with Racing Side Mirrors and PowerFlip Windshield.
- Lights sold separately.

Lonestar Racing Light Rack

Maverick X3, Maverick X3 MAX

715003948

- Designed for use with Baja Designs XL80 LED Light and Baja Designs XL Sport LED Light.
- Accommodates up to two pairs of XL Lights.
- Not compatible with Racing Side Mirrors and PowerFlip Windshield.
- Compatible with Lonestar Racing Aluminum Roof, Aluminum Roof and Sport Roof.
- Lights sold separately.

Chase Lights

Maverick X3, Maverick X3 MAX

715002887

- Designed by Can-Am to make you visible to vehicles riding behind you, especially in dusty or harsh conditions.
- Feature in-dash switches to activate one of the two modes and to choose among 11 different high-visibility colored light patterns (blue, red and yellow).
- Trail Mode: Serves as a tail light and as a brake light.
- Race Mode: Displays light patterns and serves as a brake light (brake light function can be deactivated for racing applications).
- Modular to allow installation with rear roll cage mounted accessories.
- Plug-and-play installation.

Light Support Bar

Maverick X3, Maverick X3 MAX

715003529

- Sleekly styled rugged aluminum construction.
- Accommodates light bars and spotlights with or without any roof and windshield combination.
- Full vehicle width to allow the installation of any large LED light bar.
- Required for light installation on vehicle's roof.
- Not compatible with Lonestar Racing Aluminum Roof.
- Lights sold separately.

Mounting Kit for 39" (99 cm) LED Light Bar*(Not illustrated)*

Maverick X3, Maverick X3 MAX

715005822

- Required for installation of the 39" (99 cm) double stacked LED Light Bar.
- Includes wiring and support bracket.
- Light Support Bar required for installation.

Light Power Cable*(Not illustrated)*

Maverick X3, Maverick X3 MAX

715003417

- Required for installation of 10" (25 cm), 15" (38 cm) and Double Stacked LED Light Bars and 4" (10 cm) Round LED Lights.
- For bumper and roof mounting locations.

AUDIO & COMMUNICATION SYSTEMS

AUDIO

Can-Am Audio Roof



Maverick X3

715007130

- Full roof with sleek built-in audio.
- Fully sealed and waterproof.
- Easy to install: one wire connects the roof to the vehicle's electronics.
- Four 8" speakers, one 400 RMS and 800 peak watt amplifier, and one Head Unit supplied by Rockford Fosgate Audio.
- Multi-colored RGB LED accent lighting around each speaker.
- 2.7" color display with Bluetooth and Pandora connectivity.
- Flip Kit-compatible.
- Not compatible with the Adventure Roof Rack and the Upper Soft Doors.

Can-Am Audio Roof



Maverick X3 MAX

715006709

- Full roof with sleek built-in audio.
- Fully sealed and waterproof.
- Easy to install: one wire connects the roof to the vehicle's electronics.
- Six 8" speakers, one 400 RMS and 800 peak watt amplifier, and one Head Unit supplied by Rockford Fosgate Audio.
- Multi-colored RGB LED accent lighting around each speaker.
- 2.7" color display with Bluetooth and Pandora connectivity.
- Flip Kit-compatible.
- Not compatible with the Adventure Roof Rack and the Upper Soft Doors.

Can-Am Audio Roof Flip Kit



Maverick X3, Maverick X3 MAX

715007131

- Combines with Audio Roof 715007130 or 715006709 for Flip option.

MTX Central Speakers



Maverick X3 MAX

715004748

- Top mounted central speaker case holding two 6.5" (16.5 cm)/100W speakers.
- Designed to be Can-Am-tough in the most demanding riding conditions.
- Perfect add-on to the Complete MTX Audio System for a 7-speaker system or as a stand-alone system by plugging the AUX input jack directly into your music device.
- Not compatible with Lonestar roofs.

Complete MTX Audio system



Maverick X3, Maverick X3 MAX

715002873

- Bluetooth 5¹ equipped 400 W RMS/800 W peak audio system by MTX.
- Designed to be Can-Am-tough in the most demanding riding conditions.
- Includes front-dashboard and rear-roll-cage mounted stereo speakers and head unit with an integrated 6.5" (16.5 cm) subwoofer.
- Add the Electronic Device Holder to securely hold your Bluetooth device ready to play your favorite tunes.

Can-Am Subwoofer



Maverick X3, Maverick X3 MAX

715004956

- Powerful Rockford Fosgate Underseat 10" Subwoofer speaker box.
- Easy plug-and-play connections to Audio Roof system.
- Sturdy construction tough enough to withstand harsh environments and sealed against moisture and dirt.
- Requires 1 Amplifier kit (715007227) for 1 or 2 subwoofers.
- Fits two per vehicle: under driver or passenger seat.

Can-Am Amplifier kit



Maverick X3, Maverick X3 MAX

715007227

- A powerful 400 W amplifier to feed up to two Underseat Subwoofers.
- Easy plug-and-play connections to Audio Roof system and subwoofer.
- Installation plate and wiring included.

Electronic Device Holder



Maverick X3, Maverick X3 MAX

715002874

- A great in-ride entertainment system platform.
- Robust injected-polypropylene construction allows for right fit and easy installation.
- Adjustable unit safely holds most tablets and smartphones measuring between 5.1" (13 cm) and 10" (25.4 cm) (with protective case).
- Combines seamlessly with Complete MTX Audio System and Rugged Radios Intercom System.
- Allows the installation of Garmin Montana 680T GPS.
- Integrated storage (1 gal [3.8 L] capacity) with access to the dash 12V outlet for device charging.

COMMUNICATION SYSTEMS**Rugged Radios Intercom System**

Maverick X3, Maverick X3 MAX

715002891 • US only

- Specifically designed to facilitate clear in-vehicle communication between driver and passenger(s).
- Expandable to 4 people.
- Includes music port for enjoying your favorite tunes.
- Seamless integration with in-dash switch panel.
- May be synched with the Rugged Radios Car-to-Car System (715003440). Accessory not available in Canada.
- Power Cable is required for installation on MAX models.

Rugged Radios Helmet Headset Kit for Rear Passengers

With Rugged Radios Intercom System

715004380 • US only

- Additional 12' (3.7 m) cables and Helmet Speaker/Mic Kits to upgrade your 2-person intercom system to a 4-person system.
- Power Cable is required for installation on MAX models.

ELECTRICAL & ELECTRONIC ACCESSORIES

ELECTRICAL**Seat Heater**

Maverick X3, Maverick X3 MAX

715006112

- 25 W seat heater delivers chill-free riding comfort.
- High/low temperature settings allow you to control the desired degree of warmth.
- This kit includes one carbon fiber seat heater, foam sheet and in-dash switch.
- Installs directly in the original seat cushion.
- Heated Accessories Wiring Harness (710005757) is required for front seat installation.
- Heated Accessories Wiring Harness (715006004) is required for rear seat installation.

Heated Visor Outlet

Maverick X3, Maverick X3 MAX

715001246

- Strategically positioned on vehicle to maintain your agility.
- Optional visor outlet that delivers fog-free riding.
- Quick and easy installation.
- Sold individually.
- Heated Visor not included.

Heated Accessories Wiring Harness*(Not illustrated)*

Maverick X3, Maverick X3 MAX

710005757

- Electric harness required to hook up and operate front heated seats, heated steering wheel and heated grab bar.
- Heated Accessories Wiring Harness (715006004) is required for rear seat installation.

Auxiliary Battery Installation Kit*(Not illustrated)*

Maverick X3, Maverick X3 MAX

715006315

- Allows you to add a second 18Ah battery for a dual battery setup necessary to power auxiliary electrical components such as sound systems or winches.
- Equipped with an IP67-rated waterproof electronic module that will prevent your auxiliary electrical components from draining your starting battery.
- Kit includes an additional battery junction block, all necessary wiring and the battery holder.
- Both batteries are perfectly integrated, in stock location, behind the passenger seat.
- Additional battery (410301203), plus battery hardware (250000282) sold separately.

ELECTRONIC ACCESSORIES**Garmin® Montana® 680T GPS**

Maverick X3, Maverick X3 MAX

715002830

- Rugged and waterproof, the Montana 680T is element-proof.
- 4" (10.16 cm) dual-orientation, sunlight-readable touchscreen and glove-friendly touchscreen display, to give you vivid colors and high-resolution images.
- 8-megapixel autofocus camera automatically geotags photos.
- Tracks both GPS and GLONASS satellites for improved positioning and typically faster fixes.
- Preloaded TOPO maps, plus 1-year BirdsEye Satellite Imagery subscription.
- 3-axis compass with barometric altimeter.
- Electronic device holder (715002874) is required for installation.
- Includes a preloaded map for US.
- European Version (EC compliant).
- Includes preloaded European recreation map. (715003456)

USB Power Outlet Kit

Maverick X3, Maverick X3 MAX

219400510

- Recharges your electronic devices while riding* (smartphone, MP3, heating gear, etc.).
- Dual port USB connectors.

*The power outlet is not capable of recharging all device types while riding.

Lighted Whip Flag

Maverick X3, Maverick X3 MAX

715002886

- A must for riding the dunes.
- 5 W Cree LED.
- 5 colored lenses to allow personalization.
- Glow-through whip, quickly removable and replaceable pole.
- Increases vehicle's visibility.
- Meets most dune-area requirements.
- Die cast aluminum base, acetal hand nut.
- Includes mounting brackets and wiring.
- 4' (1.2 m) flag mounts on top of the roll cage.
- Can be installed on both sides of a vehicle.

Jump Starter**715005062**

- IPX3 water-resistant and enclosed output ports.
- 4 LED battery indicators for easy read on battery charge level.
- Compact design, will conveniently fit in your backpack, glove box or any other storage compartment.
- 2.4A + 1A/5V USB ports for fast charging of all USB devices.
- Smart cable provides protection against reverse polarity, short circuit, low voltage, high temperature and reverse charging.
- Built-in LED light (3 modes).
- Content: 300CA jump starter, SA858 smart cable clamp, MC-USB to USB charging cable, travel bag, user manual.
- Not EC compliant.

Quick Connect Battery Cable**715005408**

- Quickly and easily connect and charge different batteries with your charger.
- Included in the Battery Charger/Maintainer.
- Sold individually.

Quick Connect Cable with Battery Indicator**715006055**

- Quickly and easily connect and charge different batteries with your charger.
- 3-color LED indicator provides constant battery health indication.
- Sold individually.

Digitally Encoded Security System (D.E.S.S.) Green KeyMaverick X3 (Turbo/TurboR/
Turbo RR motorization)**710005232**

- Top-security anti-theft protection for your vehicle.
- Encrypted chip technology restricts access to your vehicle's electronic ignition system.
- One vehicle/one code.
- A vibration/shock-resistant ball-and-socket design that ensures a reliable connection.
- 3 programmable modes:
 - Work mode: Limits vehicle speed to 40 kph (25 mph) but does not limit engine torque.
 - Normal mode: Limits vehicle speed to 70 kph (44 mph) and 50% torque reduction.
 - Performance mode: No restrictions.

WINCHES & HITCHES

CAN-AM HD WINCHES

Can-Am HD 4500 Winch

Maverick X3, Maverick X3 MAX

715006416

- Ergonomic clutch handle.
- Rugged all-steel gears and bushings for more torque and durability.
- Automatic 100% load-holding brake.
- Sealed solenoid for all-weather protection.
- Weather sealed corded remote and dash mounted switch.
- EC compliant.
- Pulling strength capability of 4,500 lb (2,041 kg).
- 43' of 1/8" (13.1 m of 6.3 mm) wire steel cable.
- Heavy-duty 4-way roller fairlead.
- Winch Electrical Harness (715003585) and winch compatible front bumper are required.

Can-Am HD 4500-S Winch

Maverick X3, Maverick X3 MAX

715006417

- Ergonomic clutch handle.
- Rugged all-steel gears and bushings for more torque and durability.
- Automatic 100% load-holding brake.
- Sealed solenoid for all-weather protection.
- Weather-sealed corded remote and dash mounted switch.
- Pulling strength capability of 4,500 lb (2,041kg).
- 50' of 1/4" (15.2 m of 6.35 mm) synthetic rope.
- Corrosion-proof aluminum hawse fairlead.
- Winch Electrical Harness (715003585) and winch compatible front bumper are required.

WARN[®] VRX WINCHES

WARN VRX 45 Winch

Maverick X3, Maverick X3 MAX

715006110

- Extreme IP68-rated waterproof sealing keeps the elements out.
- Durable all-metal construction.
- Black powder-coated finish and stainless steel fasteners for corrosion resistance.
- Robust new clutch design based on 70+ years of WARN 4 WD hub lock know-how.
- Load-holding brake for great control.
- Smooth and reliable all-metal three-stage planetary gear train.
- Dash-mounted rocker control.
- Limited lifetime warranty (mechanical), 3-year warranty (electrical).
- Pulling strength capability of 4,500 lb (2,041 kg).
- 50' of 1/4" (15 m of 6.3 mm) wire steel cable.
- Roller fairlead.
- Winch Electrical Harness (715003585) and winch compatible front bumper are required.

WARN VRX 45-S Winch

Maverick X3, Maverick X3 MAX

715006111

- Extreme IP68-rated waterproof sealing keeps the elements out.
- Durable all-metal construction.
- Black powder-coated finish and stainless steel fasteners for corrosion resistance.
- Robust new clutch design based on 70+ years of WARN 4 WD hub lock know-how.
- Load-holding brake for great control.
- Smooth and reliable all-metal three-stage planetary gear train.
- Dash-mounted rocker control.
- Limited lifetime warranty (mechanical), 3-year warranty (electrical).
- Pulling strength capability of 4,500 lb (2,041 kg).
- 50' of 1/4" (15 m of 6.3 mm) synthetic rope.
- Cast aluminum hawse fairlead.
- Winch Electrical Harness (715003585) and winch compatible front bumper are required.

WINCH ACCESSORIES

Can-Am HD Hawse Fairlead

Can-Am HD Winch

715006426

- A must when upgrading your winch with a synthetic cable, this corrosion-proof aluminum hawse fairlead will prevent the cable from snapping in a corner of a roller fairlead and from wearing prematurely due to the rough surface of the worn roller guide.
- Must be used with synthetic cables only.

WARN Hawse Fairlead

WARN Winch

705208797

- Double-powder-coated construction.
- Required to use the Synthetic Winch Cable (715001118) on WARN winches.
- To be used with synthetic winch cables only.

Synthetic Winch CableCan-Am HD Winch
WARN Winch**715006430**
705015070

- 50' of ¼" (15.2 m of 6.35 mm) synthetic cable for Can-Am HD winches.
- Can-Am HD Hawse Fairlead (715006426) is required when upgrading to a synthetic cable to avoid premature cable damage and wear.
- WARN Hawse Fairlead (705208797) is required when upgrading to a synthetic cable to avoid damage and premature wear of the cable.

Wire Rope ReplacementCan-Am HD Winch
WARN Winch**705014978**
715006699

- 43' of 1½/₆₄" (14.3 m of 6.3 mm) wire rope for Can-Am HD Winch.
- 55' of ¼" (16.8 m of 6.35 mm) wire rope for WARN winch kit.
- 4,500 lb (2,041 kg) pulling strength.

Synthetic Cable Extension**715001120**

- Lightweight ¼" (6.35 mm) diameter, easy to handle and won't rattle in cargo box.
- Easily attaches to winch cable to provide additional 50' (15.2 m) of distance.
- 4,500 lb (2,041 kg) single line capacity.

Winch Electrical Harness*(Not illustrated)*

Maverick X3, Maverick X3 MAX

715003585

- Required for winch installation.

Rear Winch Harness*(Not illustrated)***715006007**

- Required for installation of a winch on the S3 Rear Winch Bumper.

Wired Remote ControlWARN Winch†
Can-Am HD Winch‡**710001002**
715008121

- This kit allows winch owners to add the hand-held remote to vehicles with a stock winch.
- OEM stock winch is sold separately.
- EC compliant.

† Harness (710001023) is required to use remote control on a vehicle with a factory installed winch.
‡ Remote control (710007050) and connection socket are included.

Wireless Remote Control

WARN Winch

715002542

- The system is quick and easy to install, thanks to a wiring harness with an integrated antenna and all necessary mounting hardware.
- The system allows you to operate your winch from anywhere within a 50' (15.2 m) radius, increasing your recovery options.
- All components are weatherproof.

X rc/X mr Rear Tow Hook

Maverick X3, Maverick X3 MAX

715004450

- Offers a solid place to hook onto in case towing is needed.
- Allows you to attach most straps and hooks.
- Made of rugged ¾" (5 mm) steel plate and ½" (16 mm) steel hook tube.
- Standard on Maverick X rc and X mr models.

HITCHES**Rear Hitch**



Maverick X3, Maverick X3 MAX

715002883 • Black
715003938 • Can-Am Red

- Rugged lightweight steel construction.
- E-coated finish.
- Fixed mounting point for trailer ball to provide vehicle with towing capabilities.
- This hitch offers 1,300 lb (590 kg) of towing capacity.
- Hitch ball not included.

PERFORMANCE

SMART-LOK TECHNOLOGY

Smart-Lok Differential	Maverick X3 produced after January 1, 2017 Maverick X3 MAX	705402371
	<ul style="list-style-type: none"> Can-Am-exclusive Smart-Lok technology constitutes a true fully lockable on-the-fly front differential with electronically controlled automatic modes. Choose your differential settings according to your riding need: "2x4" for rear wheel traction only, "4x4 Front Diff Lock" for a fully locked 4 wheel drive, and "4x4 Smart Mode" that offers preset, intelligent calibrations for your type of riding. Using multiple input sources, "Smart Mode" will instantaneously engage locking with the right load at the right moment to procure maximum traction while retaining low-speed maneuverability, allowing for optimal placement and a feeling of confidence. The Smart-Lok Differential Kit comes standard with the Trail Mode. Mud, Rock and Trail Activ modes can be added by installing an additional Smart Mode Module (sold separately) to fine-tune your riding environment. Requires Performance Half Shafts (2x) and Smart-Lok Installation Kit for installation. 	
Smart-Lok Installation Kit <i>(Not illustrated)</i>	Maverick X3 produced after January 1, 2017 Maverick X3 MAX 2018 and prior Maverick X3, Maverick X3 MAX 2019 & up	715004746 715005329
	<ul style="list-style-type: none"> Required to install the Smart-Lok Differential Kit. Includes all necessary hardware and wiring for Smart-Lok Differential installation. 	
Performance Half Shaft	Maverick X3, Maverick X3 MAX Maverick X3, Maverick X3 MAX	705401634 • 64" 705402048 • 72"
	<ul style="list-style-type: none"> High-performance design ideal for off-road use, with superior protection in any riding usage. Includes CVs, shaft and boots with the best suited geometry for your Can-Am vehicle. Required to install the Smart-Lok Differential Kit. 	
Mud Smart Mode Module <i>(Not illustrated)</i>	Maverick X3, Maverick X3 MAX with Smart-Lok Differential (except Turbo RR models 2021 & up)	715005282
	<ul style="list-style-type: none"> This module allows you to add the Mud Smart Mode to vehicles with the Smart-Lok Differential Kit sold as an accessory or to change to the Mud Smart Mode on vehicles equipped with a standard Smart-Lok. The Mud Mode has been specially designed to deliver superior traction in the deepest mud holes. When high engine torque and/or slippage is detected, Smart-Lok will fully lock the front end. The system will stay locked until throttle release. Only one Smart Mode Module can be installed at a time. 	
Rock Smart Mode Module <i>(Not illustrated)</i>	Maverick X3, Maverick X3 MAX with Smart-Lok Differential (except Turbo RR models 2021 & up)	715005283
	<ul style="list-style-type: none"> This module allows you to add the Rock Smart Mode to vehicles with the Smart-Lok Differential Kit sold as an accessory or to change to the Rock Smart Mode on vehicles equipped with a standard Smart-Lok. The Rock Mode has been specially designed to help cross challenging rocks. When high engine torque is detected at low vehicle speed, Smart-Lok will progressively lock the front end and will stay engaged until throttle release to prevent wheel slippage and provide optimal traction. The progressive engagement allows for easier steering when maneuvering the vehicle. Only one Smart Mode Module can be installed at a time. 	
Trail Activ Smart Mode Module <i>(Not illustrated)</i>	Maverick X3, Maverick X3 MAX with Smart-Lok Differential (except Turbo RR models 2021 & up)	715005284
	<ul style="list-style-type: none"> This module allows you to add the Trail Activ Smart Mode to vehicles with the Smart-Lok Differential Kit sold as an accessory or to change to the Trail Activ Smart Mode on vehicles equipped with a standard Smart-Lok. The Trail Activ mode has been designed for aggressive riding, delivering the ultimate cornering precision. When high engine torque and/or an increase in vehicle speed is detected, Smart-Lok will progressively engage the front end and maintain it engaged until throttle release or vehicle speed reduction. The progressive engagement allows for smoother and lower steering effort. Only one Smart Mode Module can be installed at a time. 	

Lonestar Racing Mud Flaps with Brackets

Maverick X3, Maverick X3 MAX

715004865

- These bolt-on mud flaps make a great addition.
- Durable chromoly brackets.
- Protect trailing arms, rotors and CVs from rocks and debris.
- Sold in pairs.

Lonestar Racing Heavy-Duty Shift Plate & Knob

Maverick X3, Maverick X3 MAX

715004866

- The shift plate is made from durable stainless steel and bolts into place for a secure fit.
- The kit comes with a billet aluminum Lonestar Racing shift knob.
- Offers improved durability for the performance-oriented driver.

Lonestar Racing Outer Toe Link Boxed Gussets Roller Fairlead

Maverick X3, Maverick X3 MAX

715004868

- Protects and strengthens the middle radius rod links from rough riding conditions.
- Includes high-grade steel bolts.

Lonestar Racing Quick Release Clutch Cover Pins

Maverick X3, Maverick X3 MAX

715005045

- This kit will allow you to take off your clutch cover in seconds to access the belt tool-lessly.
- Includes 4 stainless steel "quick release" pins with clips and tethers.
- Replaces all clutch cover screws.
- This product affects the clutch cover sealing. It is highly recommended to use this product under dry riding conditions only.

Lonestar Racing Heavy-Duty Rear Boxed Radius Rod Support Plate

Maverick X3, Maverick X3 MAX

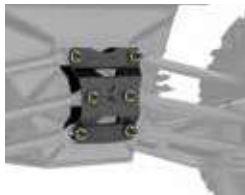
715005046

- Double-layered radius rod support plate made of high-grade steel.
- Reinforces your rod mounting location on the frame while adding a mean racing look to your vehicle.
- Easy to install.

X rc Brake Pedal

Maverick X3, Maverick X3 MAX

715004901

- Brake pedal with larger foot surface.
- This improves ergonomics and control for the rider in rock climbing conditions.

Arched Lower Suspension Links	Maverick X3, Maverick X3 MAX	715005065 • 64" models 715005066 • 72" models
--------------------------------------	------------------------------	--



- Arched lower links to free up more ground clearance.
- Standard on X mr and 2022 X rc models only.

Yoshimura† Slip-on Exhaust	Maverick X3, Maverick X3 MAX	715005183 • In-Line Triple 715002882
-----------------------------------	------------------------------	---



- Developed in collaboration with Yoshimura.
- Made from 304-grade stainless steel with brushed aluminum tip.
- Better sounding, better looking and 19% lighter than stock muffler.
- USDF/USDA approved spark arrester.
- Fuel injection system tuning not required.
- ROHVA and EPA compliant.
- Not EC compliant.

Performance Air Filter by Twin AIR†	Maverick X3, Maverick X3 MAX	715002895
--	------------------------------	------------------



- The best choice for the harshest conditions.
- Multiple staged oiled filtering foam for superior dust retaining capacity with high airflow.
- Washable and reusable.

Foam Replacement <i>(Not illustrated)</i>	Maverick X3, Maverick X3 MAX	715000713
---	------------------------------	------------------

- Replacement foam for Performance Twin Air Filter.

Snorkel Pre-filter	Maverick X3, Maverick X3 MAX (with Snorkel kit)	715005599
---------------------------	--	------------------



- Pre-filter specifically for snorkels.
- Adds extra protection to your engine in harsh riding conditions.
- Helps keep air filter cleaner.
- Filter blocks particles larger than 0.005" (0.13 mm).
- Necessary to maintain vehicle warranty when tracks are installed.

Snorkel Kit	Maverick X3, Maverick X3 MAX (2019 and prior) Maverick X3, Maverick X3 MAX (2020 & up)	715003733 715007110
--------------------	---	--



- Raises point of engine and CVT air intakes so vehicle can be semi-submersed in water or mud without the engine taking in water.
- Not compatible with S&B Particle Separator, LinQ Pivoting Rack, Lonestar Racing Rear Intrusion Bar or any rear panels or windows.
- Sealed Air Box 707800780 (sold separately) is required for installation on models manufactured before January 1, 2018.
- Standard on Maverick X3 X mr models.
- Not EC-compliant.

Radiator Relocator	Maverick X3, Maverick X3 MAX	715004937
---------------------------	------------------------------	------------------



- Relocates stock radiator to rear of cage.
- Protects it from debris and rocks.
- Prevents cooling performance loss in muddy conditions.
- Reduces hot air in the cabin.
- Easy to clean.
- Includes support hardware and hoses.
- Not compatible with any bed accessories, Rear Cage mounted accessories, Complete MTX Audio system and Upper Soft Doors (except LinQ 8 gal [30 L] Cooler Box).
- Radiator (709200703) is required for installation on 2017 models.

850 W Magneto Kit	Maverick X3, Maverick X3 MAX (2021 & up)	715006279
--------------------------	---	------------------



- Increases the magneto output to 850 W.
- Includes rotor, stator and regulator.

WARNING: Any modifications or addition of accessories may affect the handling of your vehicle. It is important to take the time to get familiar with the vehicle once modifications are made to understand how to adapt your driving behavior accordingly. Do not tamper with unauthorized modifications or install equipment not specifically certified by BRP for the vehicle. These modifications have not been tested by BRP and they may increase the risk of injury or loss of control, or render the vehicle illegal to ride. Ask your authorized BRP dealer for suitable available accessories for your vehicle.

High Output 172 HP Upgrade Kit X3

Maverick X3, Maverick X3 MAX
(2017 models)

715004700



- Performance upgrade kit for Maverick X3 2017 models only.
- Gain 18 HP for a total of 172 HP.
- Includes: Intercooler with fan, fuel pump catalyst and high performance belt.
- Installation must be done by an authorized BRP dealership to preserve the vehicle's warranty.
- C.A.R.B. Executive Order #D-799U.

172 HP Intercooler Upgrade Kit
(Not illustrated)

Maverick X3, Maverick X3 Max
(2018 and 2019)
Maverick X3, Maverick X3 Max
(2020)

715007137
715007277

- Intercooler upgrade for the Maverick X3 2018 and up.
- Installation must be done by an authorized BRP dealership to preserve the vehicle's warranty.
- Requires the power upgrade installation kit (715007111).

Power Upgrade Installation Kit
(Not illustrated)

Maverick X3, Maverick X3 MAX

7150007111

- Increases the power of the Maverick X3 from 120 HP to 172 HP.
- Includes fuel pump, clutch components and turbo adjustment.
- Installation must be done by an authorized BRP dealership to preserve the vehicle's warranty.
- Requires Maverick X3 intercooler specific to model year (715007137 or 715007277).

WARNING: Any modifications or addition of accessories may affect the handling of your vehicle. It is important to take the time to get familiar with the vehicle once modifications are made to understand how to adapt your driving behavior accordingly. Do not tamper with unauthorized modifications or install equipment not specifically certified by BRP for the vehicle. These modifications have not been tested by BRP and they may increase the risk of injury or loss of control, or render the vehicle illegal to ride. Ask your authorized BRP dealer for suitable available accessories for your vehicle.

EMERGENCY ACCESSORIES

Lonestar Racing Fire Extinguisher Support

Maverick X3, Maverick X3 MAX

715003734



- Quick-release support that allows you to slide the fire extinguisher out in a matter of seconds in an emergency situation.
- Made of billet anodized black aluminum.
- Provides you with the safety and security of having dependable emergency equipment on board.
- Fits 1.85" (4.7 cm) tubing.
- Can be fixed everywhere on the cage.
- Comes with both billet mounts, quick-pull pin, mounting plate and 2 clamps.
- Fire extinguisher sold separately.
- "Lonestar Racing for Can-Am" branded.

Fire Extinguisher

295100833



- Ideal for grease, oil and electrical fires.
- Fits with Lonestar Racing Fire Extinguisher Support Kit.
- Not EC compliant.

Emergency Kit

Maverick X3, Maverick X3 MAX

715006102 (Excludes first aid kit)
715006103



- Complete emergency kit provides all essential equipment and supplies to get out of most unfavorable situations powersport enthusiasts can find themselves in.
- Includes: Jumper Cables, Air Compressor, Tyre Repair Kit, Ratchet Tie-Down, Duct Tape, 3,300 lb (1,500 kg) Tow Strap, Zip-Ties, Cloth Rags.

TRAILERING

Trailer Cover <i>(Not illustrated)</i>	Maverick X3	715005813
	Maverick X3 MAX	715005814

- Heavy-duty canvas made of UV-resistant solution-dyed polyester.
- Inner soft liner protects windshield and colored panels from abrasion.
- All high-abrasion areas are reinforced with a double canvas layer.
- Weather-resistant trailering cover protects your vehicle during storage and transportation.
- Opening for fuel cap and cabin access on passenger side.
- Quick and easy installation.
- Designed to perfectly fit your vehicle with or without Can-Am accessories.

Bolt-On⁺ Retractable Ratcheting Tie-Downs		295101072
---	--	------------------



- Perfect for transporting your powersport vehicle or securing loads.
- Mounts easily: Bolts on any flat surface (e.g., truck bed or frame).
- 1" x 6' (2.5 cm x 1.8 m) tie-down strap with heavy-duty stitching that delivers a 500 lb (226 kg) working load strength and 1,500 lb (680 kg) break strength.
- Convenient retractable push button automatically slackens, spools and stores away strap, while the ratchet mechanism tightens the strap snugly to secure your vehicle or load into place.
- Rubber ratcheting handle provides firm grip, and the hook is vinyl coated to protect whatever surface it hooks into.
- Sold in pairs.

Ratchet Tie-Downs		715008309 • Black/Gray
--------------------------	--	-------------------------------



- 400 lb (181 kg) safe working load.
- 1" x 10' (2.5 cm x 3 m) strap with Sea-Doo, Ski-Doo and Can-Am logos.
- Deluxe ratchet with rubber handle.
- Coated S hooks.
- Pack of 2.

Heavy-Duty Ratchet Tie-Down		715008308
------------------------------------	--	------------------



- 1,000 lb (454 kg) safe working load.
- 1.5 in. x 6 in. (38 mm x 1.8 mm) strap with BRP brands.
- Deluxe ratchet with rubber handle.
- Black-coated clip hooks.
- 12" (300 mm) webbing included.
- Pack of two.

APACHE TRACK SYSTEMS

NON-STOCKED ITEM, SPECIAL ORDER ONLY.

WINTER TRACKS

1-YEAR WARRANTY

Apache Backcountry LT Track System	Maverick X3, Maverick X3 MAX	715004734
---	------------------------------	------------------



- Tracks designed to deliver the best snow performance on the market with unmatched flotation level and traction on snow surface.
- Large contact patch, 37% bigger than the Apache 360 LT.
- Impressive added ground clearance of 7" (18 cm) helps keep the vehicle over the snow.
- Lightweight snowmobile-inspired rail design.
- Aggressive track design with 2" (5 cm) lug height for maximum traction on snow.
- Apache Backcountry LT Mounting Kit, Track DPS Module and Engine and CVT Pre-Filter are required.
- Fine-tune your track system using extra Idler Wheels, Sliders with Vespel Inserts and Rail Ice Scratcher.
- For winter use only.
- Track installation will affect vehicle width and length.

Apache Backcountry Mounting Kit <i>(Not illustrated)</i>	Maverick X3, Maverick X3 MAX	715004397 • 64" models 715004394 • 72" models
--	------------------------------	--

- Required for installation of the Apache Backcountry Track LT System.
- DPS module and Pre-Filter are required and sold separately.

YEAR-ROUND TRACKS

2-YEAR WARRANTY

Apache 360 LT Track System

Maverick X3, Maverick X3 MAX

715005103



- Multifunctional tracks designed to support heavy loads and to fit on most Can-Am off-road vehicles.
- Extra contact patch adjustment for better performance over rough terrain.
- Contact patch is 7% to 9% bigger than the Apache 360's.
- Average ground clearance of 16" (41 cm).
- 1" (2.5 cm) lugs in the front and 1.25" (3.2 cm) in the back.
- Apache 360 LT Mounting Kit, Track DPS Module and Engine and CVT Pre-Filter Kit are required.
- EC compliant.

Apache 360 LT Mounting Kit

(Not illustrated)

Maverick X3, Maverick X3 MAX

715004392 • 64" models

715004393 • 72" models

- Required for installation of the Apache 360 LT Track System.
- Track DPS Module and Pre-Filter not included.

ACCESSORIES

Rail Ice Scratchers

Apache Backcountry LT Track System

860201728



- Provide additional lubrication in hard and icy conditions.
- Rail mounted, small, light.
- Design expands on coil concept to allow reversing without damage.
- Easily stored when not in use.
- Extends slider life.

Apache Backcountry LT Wheel Kit

Apache Backcountry LT Track System

715006293



- Additional wheel kit for Backcountry LT rear tracks.
- Reduces drag and rolling resistance in hard snow conditions or when transporting heavier loads.
- Extends slider life in hard snow conditions.
- Includes two wheels, cross shaft and mounting hardware per kit to service one track corner.
- Up to two kits per rear track can be installed.

Sliders with Vespel[®] Inserts

Apache Backcountry LT Track Systems

503194815



- Use DuPont Vespel inserts for less friction.
- Longer life.
- Can be cut to desired length.
- 8 needed per vehicle.
- Sold individually.

Track DPS Module

(Not illustrated)

Maverick X3, Maverick X3 MAX (Turbo RR engine only)

715006266

Maverick X3, Maverick X3 MAX (except Turbo RR engine)

715007338

- Innovative DPS module that ensures speedometer accuracy and optimized steering assist, making for perfect track control and riding ease.
- Required to install the Apache Track Systems.

Engine & CVT Air Intake Pre-Filter

Maverick X3, Maverick X3 MAX (except X mr models)

715005600



- Adds extra protection to your engine in harsh riding conditions.
- Helps keep air filter cleaner.
- Filter blocks particles larger than 0.007" (0.19 mm).
- Easy installation.
- Not compatible with S&B Particle Separator.
- Necessary to maintain vehicle warranty when tracks are installed.

Required to install the Apache Backcountry LT and Apache 360 LT Track Systems.

Snorkel Pre-Filter

Maverick X3, Maverick X3 MAX (with Snorkel kit)

715005599



- Pre-filter specifically for snorkels.
- Adds extra protection to your engine in harsh riding conditions.
- Helps keep air filter cleaner.
- Filter blocks particles larger than 0.005" (0.13 mm).
- Necessary to maintain vehicle warranty when tracks are installed.

Required to install the Apache Backcountry LT and Apache 360 LT Track Systems.

ProMount PLOWS

NON-STOCKED ITEM, SPECIAL ORDER ONLY.

CAN-AM ProMount STEEL PLOW KITS

Can-Am ProMount Steel 72" (183 cm) Plow Kit	Maverick X3, Maverick X3 MAX	<ul style="list-style-type: none"> ■ 715008176 • Black ■ 715008177 • Yellow
--	------------------------------	---



- These kits include:
 - Can-Am ProMount Steel Blade.
 - Push Frame with Quick-Attach System.
 - Can-Am ProMount Mounting Plate.

CAN-AM ProMount STEEL BLADES

Can-Am ProMount Steel 72" (183 cm) Blade	Fits ProMount Push Frame	<ul style="list-style-type: none"> ■ 715004474 • Black ■ 715006021 • Yellow
---	--------------------------	---



- Plow blade made from 12-gauge steel.
- Replaceable wear blade.
- Large pin designed for easy blade rotation to eliminate snow buildup at pivot point.
- Blade design provides best snow roll-off at any angle.
- Clears 66" (168 cm) when plow is fully angled.
- Blade height of 17" (43 cm).
- Compatible with Can-Am ProMount Blade accessories to further enhance plow versatility.
- Not compatible with S3 High Clearance front A-Arm.

CAN-AM ProMount ANGLE PLOWS

Can-Am ProMount 72" (183 cm) Steel Oneway State Blade	Fits ProMount Push Frame	715007264
--	--------------------------	------------------



- Make the job easier with the right tools, clear long alleys and make the task easier by sending the snow further out of the way.
- Wing end of plow measures 26" (67 cm) high and tapers down to 16" (41 cm).
- One-way "winged" state plow designed to throw snow higher.
- Rubber flap designed to keep snow away from the driver.
- Can-Am branded.

CAN-AM ProMount FLEX2 PLOW KIT

Can-Am ProMount Flex2 72" (183 cm) Blade	Maverick X3, Maverick X3 MAX	715008175
---	------------------------------	------------------



- These kits include:
 - Can-Am ProMount Flex2 Blade.
 - Push Frame with Quick-Attach System.
 - Can-Am ProMount Mounting Plate.

CAN-AM ProMount FLEX2 BLADES

Can-Am ProMount Flex2 72" (183 cm) Blade	Fits ProMount Push Frame	715004485
---	--------------------------	------------------



- Plow blade made of UHMWPE, flexible and impact absorbing material prevents damaging your plow when accidental impact occurs.
- Replaceable wear blade.
- Large pin designed for easy blade rotation to eliminate snow buildup at pivot point.
- Blade design provides best snow roll-off at any angle.
- Clears 66" (168 cm) when plow is fully angled.
- Blade height of 17" (43 cm).
- Compatible with Can-Am ProMount Blade accessories to further enhance plow versatility.

CAN-AM ProMount PLOW ACCESSORIES

Can-Am ProMount Edge Markers

Maverick X3, Maverick X3 MAX

715004206



- Help locate the edges of your plow.
- Height: 24" (60 cm).
- Sold in pairs.
- Compatible with Can-Am ProMount Steel and Flex2 Blades with or without Blade Extensions (except for the Can-Am ProMount Steel 54" (137 cm) Blades).

Can-Am ProMount 66" (168 cm) Plastic Wear Blade

Maverick X3, Maverick X3 MAX

715004482

Can-Am ProMount 72" (183 cm) Plastic Wear Blade

Maverick X3, Maverick X3 MAX

715004483



- Ideal to prevent leaving marks on your driveway.
- Compatible with Can-Am ProMount 72" (183 cm) Blades.

Can-Am ProMount Drift Cutters

Maverick X3, Maverick X3 MAX

715006258



- Help keep snow in the plow.
- Dimensions: 17" x 13" (43.2 cm x 33 cm).
- Sold in pairs.
- Compatible with Can-Am ProMount Steel and Flex2 blades with or without Blade Extensions (except for the Can-Am ProMount Steel 54" (137 cm) Blades).

Can-Am ProMount Blade Extensions

Maverick X3, Maverick X3 MAX

■ **715004205** • Black
 ■ **715005319** • Yellow



- These conveniently extend your Can-Am ProMount Blade.
- Add 3" (8 cm) each side.
- Compatible with Can-Am ProMount Blades (except for the Can-Am ProMount Steel 54" (137 cm) Blades).
- Longer Wear Blade can be installed to go over the extra length given by the extensions.

Back Drag Blade
 (Not illustrated)

ProMount Plows (60" and more)

715007794

- ¼ thick steel swivel scraper.
- Lifts up when the vehicle is moving forward so as not to affect the scraping.
- Increased capacity to pull snow.
- More aggressive scraping in reverse mode.
- Lifts the scraper off the ground so that it scrapes evenly.
- Adjustable in length for compatibility with 60", 66" and 72" blades.
- Compatible with ProMount blades (Flex and Steel).
- Not compatible with Backcountry Track Kit.

Curved Wear Blade
 (Not illustrated)

Maverick X3, Maverick X3 MAX

715007793 • 72" (183 cm)

- Wear blade designed with a folded back bottom lip.
- The increased surface allows for less digging while plowing uneven surfaces.
- Ideal for snow covered gravel, grass, paver stone and other soft surfaces.

CAN-AM ProMount CUSTOM SOLUTIONS

Can-Am ProMount Push Frame with Quick-Attach System	Maverick X3, Maverick X3 MAX	715008116
--	------------------------------	------------------



- Heavy-duty steel tubes designed to withstand the roughest use.
- Mid-mount carriage provides ultimate push strength and traction.
- Designed for maximum plow lift height.
- Features a self-aligning quick-attach system, an easy foot release pedal and an ergonomic handle for plow angle adjustment.
- Plow Limit Switch recommended to extend winch cable lifespan.
- Can-Am ProMount Mounting Plate required for installation.
- Blade swivels left or right, 5 positions.
- Large pin designed for easy blade rotation to eliminate dirt and snow buildup at pivot point.
- Plow Roller Fairlead included.

Can-Am ProMount Push Frame Extension	Maverick X3, Maverick X3 MAX	715006257
---	------------------------------	------------------



- 12" (30 cm) push frame extension required when plow is installed with Apache Track systems.

Can-Am ProMount Mounting Plate	Maverick X3, Maverick X3 MAX	715008197
---------------------------------------	------------------------------	------------------



- Required to install the Can-Am ProMount Push Frame with Quick-Attach System.
- Mounting plate precision designed to stay on year round without compromising ground clearance.
- Comes with the Plow Roller Fairlead.
- Not compatible with S3 High Clearance Front A-Arm.

Plow Roller Fairlead	Maverick X3, Maverick X3 MAX	705203753 • Conical Roller Fairlead
-----------------------------	------------------------------	---



- Larger diameter lower roller reduces wear on wire rope for plow application.
- Can be used with all ProMount plows.

Can-Am ProMount Plow Angling System	Maverick X3, Maverick X3 MAX	715006022
--	------------------------------	------------------



- Converts your plow system into an easy-to-control unit from the driver's seat.
- Allows you to have full up/down and left/right plow control at your fingertips by using the supplied joystick.
- Using one hand to control all plow motions will allow you to easily concentrate and manage your plowing tasks.
- Not compatible with Apache Backcountry LT Track System.
- Winch and plow sold separately.

ProMount Plow Limit Switch <i>(Not illustrated)</i>	Maverick X3, Maverick X3 MAX	715006259
---	------------------------------	------------------

- For controlling the cable tension when over-raising your plow system.
- Prevents winch, plow push frame and vehicle damage.
- Sensor relocated for optimal lift height.

TYRES & RIMS

TYRES

Maxxis[®] Bighorn 2.0 Tyre		705402080 • Front 705502603 • Rear 705402168 • Front 705502665 • Rear
--	--	--



- Front · 28" x 9" x 14".
 - Rear · 28" x 11" x 14".
- Compliant with European class T regulations.
- Front · 27" x 9" x 14".
 - Rear · 27" x 11" x 14".

Maxxis Liberty Tyre



Maverick X3 X rc

705402143 • Front

705402464 • Rear

- Engineered for performance driving and to give you and your side-by-side freedom in a variety of terrains.
- 8-ply radial construction.
- Front: 30" x 10" x 14".
- Rear: 32" x 10" x 15".

Maxxis Bighorn X ds Tyre

(Not illustrated)

705402081 • Front

705502604 • Rear

- Front · 29" x 9" x 14".
- Rear · 29" x 11" x 14".

Maxxis Bighorn X rs Tyre

(Not illustrated)

705402082

- Front & Rear · 30" x 10" x 14".

RIMS

14" Maverick X3 X mr Rim



Maverick X3, Maverick X3 MAX

705402256

- Black with clear coat aluminum rim.

14" Maverick X3 Beadlock Rim



Maverick X3, Maverick X3 MAX

■ **705402207** • Black and machined

■ **705402173** • Black

- Black aluminum rim with machined face and clear coat.
- Choice of beadlock color (not included).
- Needs 16 bolts (250000893) for installing the beadlock.

14" Maverick X3 Rim



Maverick X3, Maverick X3 MAX

705401965 • Front

705502493 • Rear

- Black with clear coat aluminum rim.
- Front: 14" x 7" Offset = 55 mm.
- Rear: 14" x 8" Offset = 76 mm.

14" Maverick X3 Beadlock Rim



Maverick X3, Maverick X3 MAX

705402393 • Front

705502814 • Rear

- Black with clear coat aluminum rim.
- Choice of beadlock color.
- Needs 16 bolts (250000893) for installing the beadlock.
- Front: 14" x 7" Offset = 55 mm (For Xrs = Front and rear).
- Rear: 14" x 8" Offset = 76 mm.

14" Maverick X3 Beadlock Ring



Maverick X3 & Maverick X3 MAX
(X rs, X ds models only)

■ **705401709** • Black

■ **705401913** • Gold

■ **705402358** • Can-Am Red

■ **705402472** • Manta Green

- Cast aluminum beadlock.
- Must be installed on Front Rim (705402393) and Rear Rim (705502814).

EXPLORE AN ENTIRE WORLD OF ADVENTURE WITH ALL OF OUR BRP PRODUCTS. BRP.COM



ski-doo LYNX SEA-DOO can-am ROTAX ALUMACRAFT Manitou QUINTREX



CAN-AMOFFROAD.COM



830201334